



ES2AB THRU ES2JB

Reverse Voltage - 50 to 600 Volts Forward Current - 2.0 Ampere

SURFACE MOUNT SUPER FAST RECOVERY RECTIFIER

Features

- ◆ The plastic package carries Underwriters Laboratory Flammability Classification 94V-0
- ◆ For surface mounted applications
- ◆ Low reverse leakage
- ◆ Built-in strain relief, ideal for automated placement
- ◆ High forward surge current capability
- ◆ High temperature soldering guaranteed:
- ◆ 250°C/10 seconds at terminals
- ◆ Glass passivated chip junction

Mechanical Data

Case : JEDEC DO-214AA/SMB Molded plastic body
Terminals : Solder plated, solderable per MIL-STD-750, Method 2026
Polarity : Polarity symbol marking on body
Mounting Position : Any
Weight : 0.003 ounce, 0.095 grams

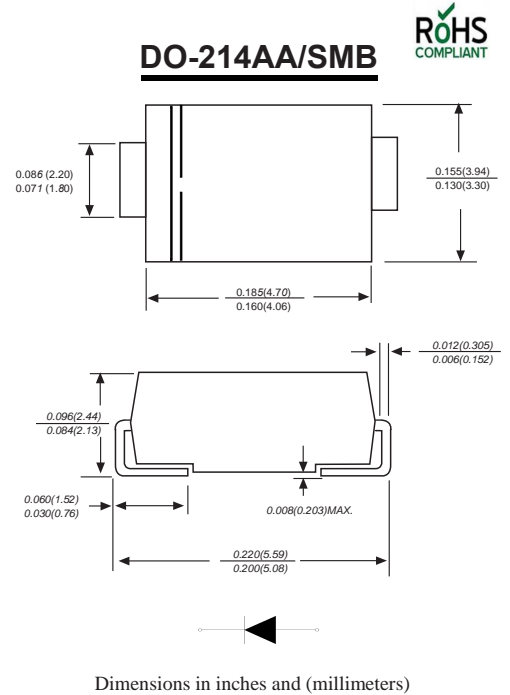

Maximum Ratings And Electrical Characteristics

Ratings at 25°C ambient temperature unless otherwise specified.

Single phase half-wave 60Hz, resistive or inductive load, for capacitive load current derate by 20%.

Parameter	SYMBOLS	ES2AB	ES2BB	ES2CB	ES2DB	ES2EB	ES2GB	ES2JB	UNITS
		MDD ES2AB	MDD ES2BB	MDD ES2CB	MDD ES2DB	MDD ES2EB	MDD ES2GB	MDD ES2JB	
Maximum repetitive peak reverse voltage	V_{RRM}	50	100	150	200	300	400	600	V
Maximum RMS voltage	V_{RMS}	35	70	105	140	210	280	420	V
Maximum DC blocking voltage	V_{DC}	50	100	150	200	300	400	600	V
Maximum average forward rectified current at $T_L=55^\circ\text{C}$	$I_{(AV)}$	2.0							A
Peak forward surge current 8.3ms single half sine-wave superimposed on rated load (JEDEC Method)	I_{FSM}	50							A
Maximum instantaneous forward voltage at 2.0A	V_F	1			1.25		1.70		V
Maximum DC reverse current at rated DC blocking voltage $T_A=25^\circ\text{C}$ $T_A=125^\circ\text{C}$	I_R	5.0			100.0				μA
Maximum reverse recovery time (NOTE 1)	t_{rr}	35							ns
Typical junction capacitance (NOTE 2)	C_J	60.0							pF
Typical thermal resistance (NOTE 3)	$R_{\theta JA}$	40.0							$^\circ\text{C}/\text{W}$
Operating junction and storage temperature range	T_J, T_{STG}	-55 to +150							$^\circ\text{C}$

- Note:**
- 1.Reverse recovery condition $I_F=0.5\text{A}, I_R=1.0\text{A}, I_{rr}=0.25\text{A}$
 - 2.Measured at 1MHz and applied reverse voltage of 4.0V D.C.
 - 3.Pulse test: Pulse width 200 sec, Duty cycle 2%
 - 4.High Temperature Solder Exemptions Applied, see EU Directive Annex 7.



ES2AB THRU ES2JB

Reverse Voltage - 50 to 600 Volts Forward Current - 2.0 Ampere

Ratings And Characteristic Curves

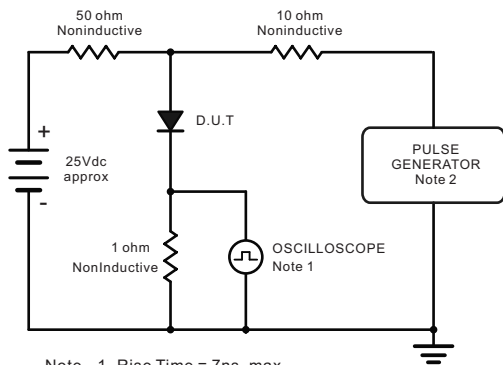

Note: 1. Rise Time = 7ns, max.
Input Impedance = 1megohm, 22pF.
2. Rise Time = 10ns, max.
Source Impedance = 50 ohms.

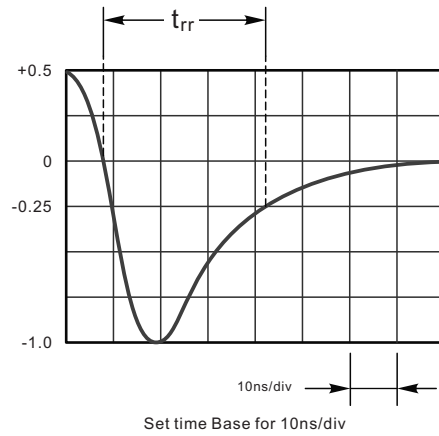

Fig.2 Maximum Average Forward Current Rating

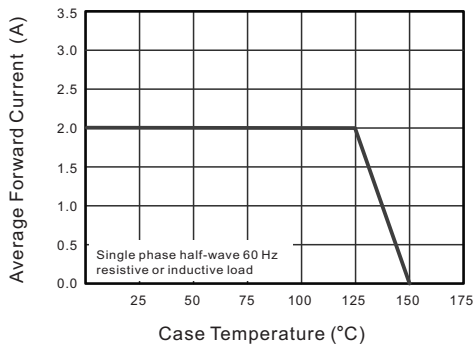

Fig.3 Typical Reverse Characteristics

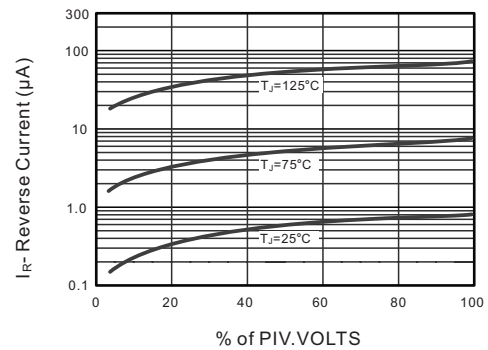

Fig.4 Typical Forward Characteristics

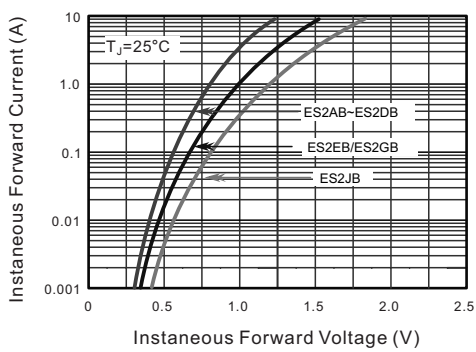

Fig.5 Typical Junction Capacitance

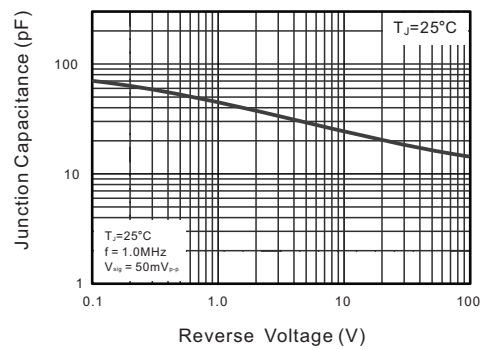
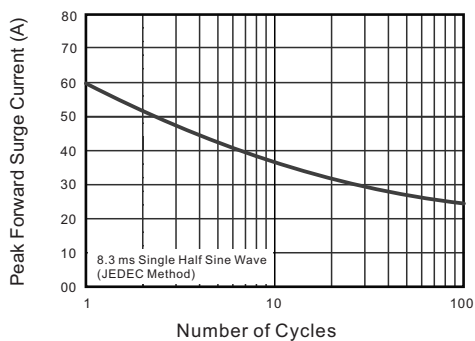

Fig.6 Maximum Non-Repetitive Peak Forward Surge Current



The curve above is for reference only.



ES2AB THRU ES2JB

Reverse Voltage - 50 to 600 Volts Forward Current - 2.0 Ampere

Packing information



unit:mm

Item	Symbol	Tolerance	SMB
Carrier width	A	0.1	3.81
Carrier length	B	0.1	5.41
Carrier depth	C	0.1	2.42
Sprocket hole	d	0.05	1 5.0
13" Reel outside diameter	D	2.0	330.00
13" Reel inner diameter	D ₁	min	50.00
Feed hole diameter	D ₂	0.5	13.00
Sprocket hole position	E	0.1	1.75
Punch hole position	F	0.1	5.55
Punch hole pitch	P	0.1	8.00
Sprocket hole pitch	P ₀	0.1	4.00
Embossment center	P ₁	0.1	2.00
Overall tape thickness	T	0.1	0.30
Tape width	W	0.3	12.00
Reel width	W ₁	1.0	12.30

Note: Devices are packed in accordance with EIA standard RS-481-A and specifications listed above.

Reel packing

PACKAGE	REEL SIZE	REEL (pcs)	COMPONENT SPACING (mm)	BOX (pcs)	INNER BOX (mm)	REEL DIA, (mm)	CARTON SIZE (mm)	CARTON (pcs)	APPROX. GROSS WEIGHT (kg)
SMB	13"	3,000	4.0	6,000	190*190*41	330	365*365*360	48,000	14.0

Suggested Pad Layout



Symbol	Unit (mm)	Unit (inch)
A	2.8	0.110
B	2.4	0.094
C	4.6	0.181
D	2.2	0.086
E	7.0	0.276

Important Notice and Disclaimer

Microdiode Electronics (Jiangsu) reserves the right to make changes to this document and its products and specifications at any time without notice. Customers should obtain and confirm the latest product information and specifications before final design, purchase or use.

Microdiode Electronics (Jiangsu) makes no warranty, representation or guarantee regarding the suitability of its products for any particular purpose, nor does Microdiode Electronics (Jiangsu) assume any liability for application assistance or customer product design. Microdiode Electronics (Jiangsu) does not warrant or accept any liability with products which are purchased or used for any unintended or unauthorized application.

No license is granted by implication or otherwise under any intellectual property rights of Microdiode Electronics (Jiangsu).

Microdiode Electronics (Jiangsu) products are not authorized for use as critical components in life support devices or systems without express written approval of Microdiode Electronics (Jiangsu).