

## Specifications

- Current rating: 2A AC, DC
- Voltage rating: 100V AC, DC
- Temperature range: -40°C ~ +105°C
- Contact resistance: 10mΩ Max.
- Insulation resistance: 1000MΩ Min.
- Withstanding voltage: 800V AC/minute
- \*Compliant with RoHS and REACH\*
- \*Meet the HF/Halogen Free, need to customize\*
- \*Contact CJT for details\*

## Standards



## Assembly layout

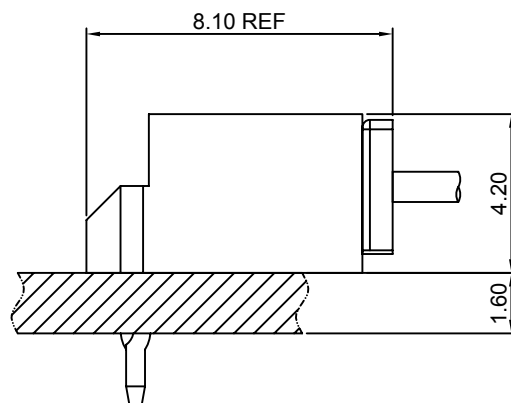
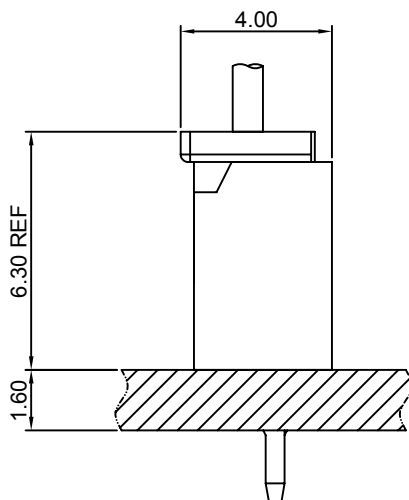



# A2010 SERIES

2.00mm pitch wire to board connector

## A2010-T

2.00mm Pitch Crimp Terminal

**Reference Informations:**

\*Used in CJT A2010H, HA-XP,A2010HA-2xXP,A2008HA-XP series Housing

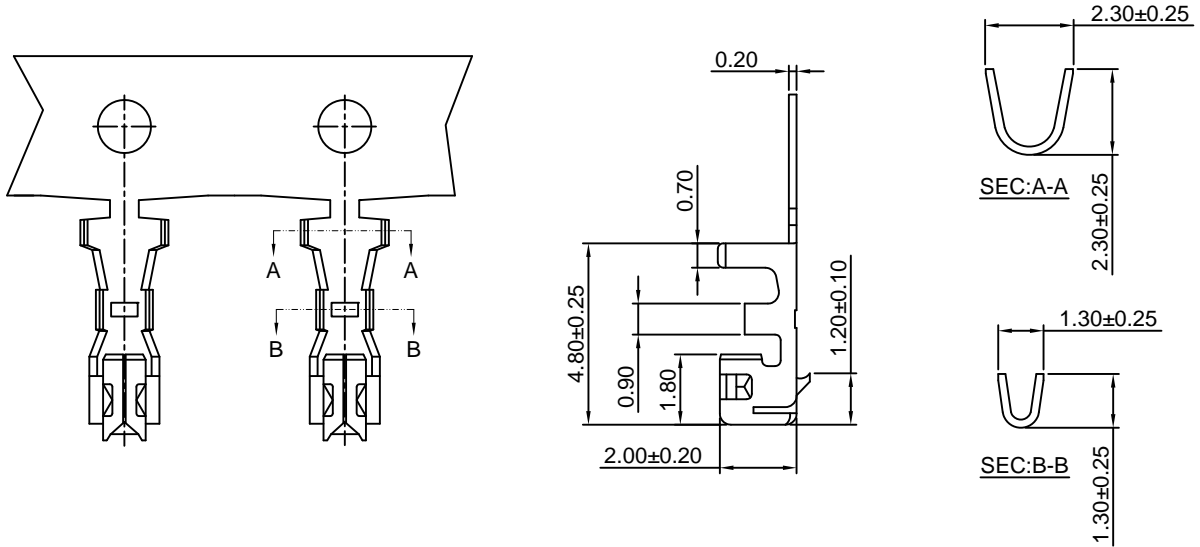

**Ordering information & Specifications:**

Unit:mm

Part NO.	Wire Range	Insulation O.D.	Material	Finish	Qty/reel
A2010-TP	AWG#24-#30	1.40mm(max)	Phosphor Bronze	Tin over Nickel	10,000 PCS
A2010-GP	AWG#24-#30	1.40mm(max)	Phosphor Bronze	Gold over Nickel	10,000 PCS

Optional Gold plating available but MOQ requested

## A2010H-XP

2.00mm Pitch Housing

**Reference Informations:**

\*Material:PBT+15%GF,UL94V-0

\*Suitable CJT A2010-T series Terminal

\*Mates with CJT A2010WV,WR-XP,A2010WV-F-XP series Wafer

\*Color:White

**Ordering Information:**

A2010H-XP - \*\*\* - \*\*  
1 2 3

1. Part No.

2. Material:

(Blank):PBT+15%GF,UL94V-0

GWT:PBT,UL94V-0,GWT 750 °C

3. Color:

(Blank):White

BK:Black

RD:Red

YL:Yellow

BL:Blue

GN:Green

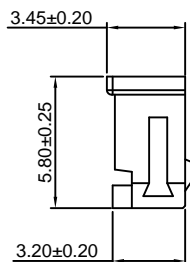
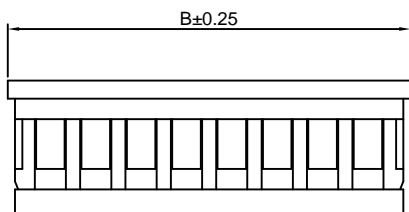
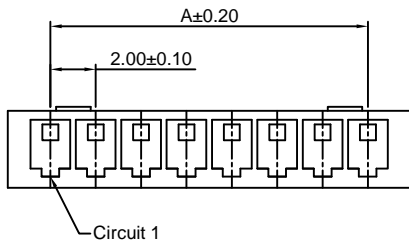
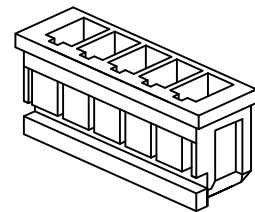

**Ordering Information & Dimensions:**

PART NO.	Dimensions	
	A	B
2P	2.00	5.80
3P	4.00	7.80
4P	6.00	9.80
5P	8.00	11.80
6P	10.00	13.80
7P	12.00	15.80
8P	14.00	17.80
9P	16.00	19.80
10P	18.00	21.80
11P	20.00	23.80
12P	22.00	25.80
13P	24.00	27.80
14P	26.00	29.80
15P	28.00	31.80

Unit: mm



# A2010 SERIES

2.00mm pitch wire to board connector

## A2010HA-XP

2.00mm Pitch Housing

### Reference Informations:

- \*Material:PBT+15%GF,UL94V-0
- \*Suitable CJT A2010-T series Terminal
- \*Color:White

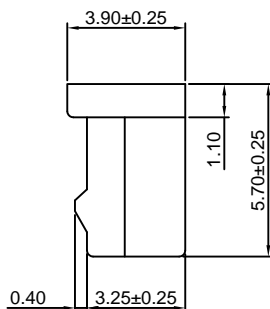
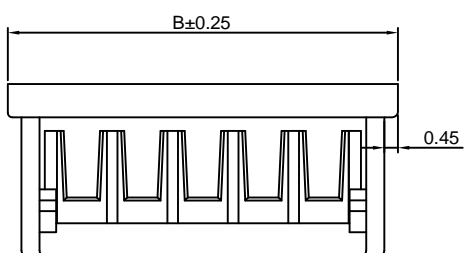
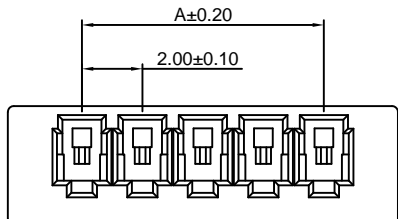

### Ordering Information:

A2010HA-XP - \*\*\*  
1                    2

1.Part No.

2.Material:

(Blank):PBT+15%GF,UL94V-0

GWT:PBT,UL94V-0,GWT 750°C

### Ordering Information & Dimensions:

PART NO.	Dimensions	
	A	B
2P	2.00	6.90
3P	4.00	8.90
4P	6.00	10.90
5P	8.00	12.90
6P	10.00	14.90
7P	12.00	16.90
8P	14.00	18.90
9P	16.00	20.90
10P	18.00	22.90
11P	20.00	24.90
12P	22.00	26.90
13P	24.00	28.90
14P	26.00	30.90
15P	28.00	32.90

Unit: mm



# A2010 SERIES

2.00mm pitch wire to board connector

## A2010HA-2xXP

2.00mm Pitch Dual Row Housing

### Reference Informations:

- \*Material:Nylon 66,UL94V-0
- \*Suitable CJT A2010-T series Terminal
- \*Mates with CJT A2010WVA-F-2xXP,A2012WVB-F-2xXP series Dual Row Wafer
- \*Color:Gray

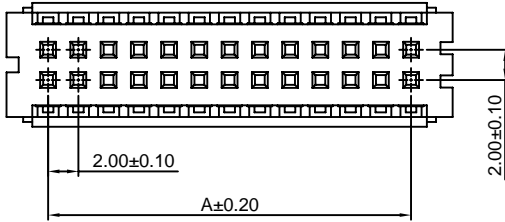

### Ordering Information:

- A2010HA-2xXP - \*\*\*  
 1  
 2
- 1.Part No.
  - 2.Material:  
 (Blank):Nylon 66,UL94V-0  
 GWT:Nylon 66,UL94V-0,GWT 750 °C

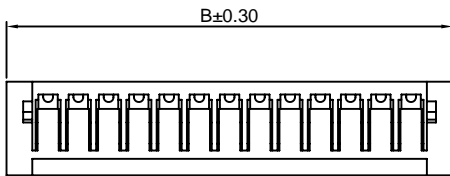
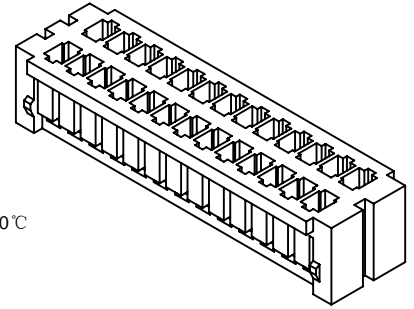

2x5P~2x14P

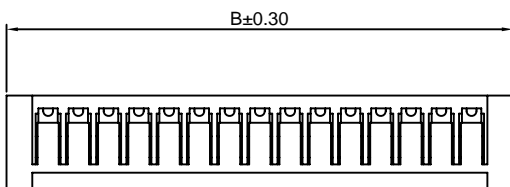
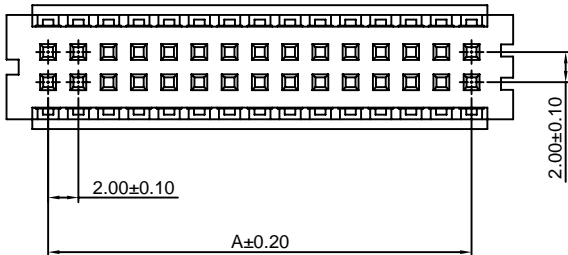
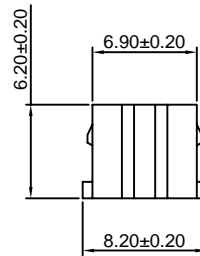

2x15P~2x30P

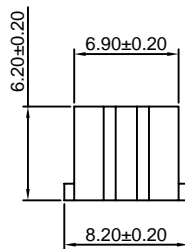

### Ordering Information & Dimensions:

PART NO.	Dimensions	
	A	B
2x5P	8.00	13.50
2x6P	10.00	15.50
2x7P	12.00	17.50
2x8P	14.00	19.50
2x9P	16.00	21.50
2x10P	18.00	23.50
2x11P	20.00	25.50
2x12P	22.00	27.50
2x13P	24.00	29.50
2x14P	26.00	31.50
2x15P	28.00	33.50
2x16P	30.00	35.50
2x17P	32.00	37.50
2x20P	38.00	43.50
2x25P	48.00	53.50
2x30P	58.00	63.50

Unit: mm

### A2010WV-XP

2.00mm Pitch 180° Wafer

**Reference Informations:**

- \*Material:Pin:Brass/Tin over Nickel  
Insulator:Nylon 66+30%GF,UL94V-0
- \*Mates with CJT A2010H-XP series Housing
- \*Color:White

**Ordering Information:**

A2010WV-XP - \*\*\* - \*\*  
1 2 3

- 1.Part No.
- 2.Material:  
(Blank):Nylon 66+30%GF,UL94V-0  
GWT:Nylon 66,UL94V-0,GWT 750°C
- 3.Color:  
(Blank):White  
BK:Black  
RD:Red  
YL:Yellow  
BL:Blue  
GN:Green

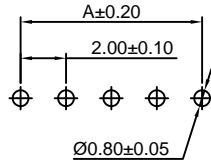
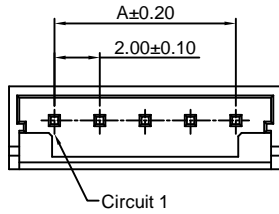
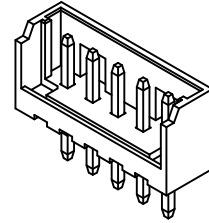

P.C.B LAYOUT

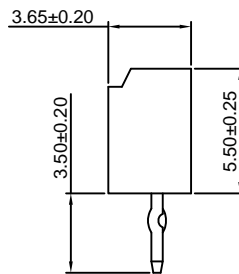
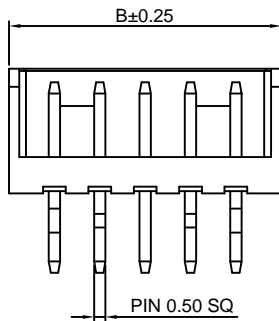

**Ordering Information & Dimensions:**

PART NO.	Dimensions	
	A	B
2P	2.00	6.00
3P	4.00	8.00
4P	6.00	10.00
5P	8.00	12.00
6P	10.00	14.00
7P	12.00	16.00
8P	14.00	18.00
9P	16.00	20.00
10P	18.00	22.00
11P	20.00	24.00
12P	22.00	26.00
13P	24.00	28.00
14P	26.00	30.00
15P	28.00	32.00

Unit: mm

### A2010WR-XP

2.00mm Pitch 90° Wafer

**Reference Informations:**

- \*Material:Pin:Brass/Tin over Nickel  
Insulator:Nylon 66+30%GF,UL94V-0
- \*Mates with CJT A2010H-XP series Housing
- \*Color:White

**Ordering Information:**

A2010WR-XP - \*\*\* - \*\*  
1 2 3

- 1.Part No.
- 2.Material:  
(Blank):Nylon 66+30%GF,UL94V-0  
GWT:Nylon 66,UL94V-0,GWT 750°C
- 3.Color:  
(Blank):White  
BK:Black  
RD:Red  
YL:Yellow  
BL:Blue  
GN:Green

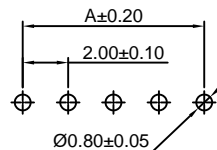
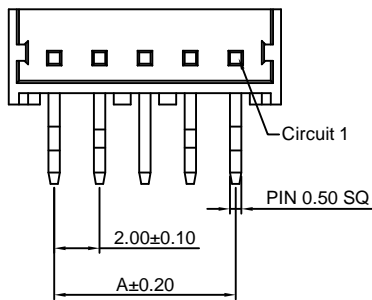
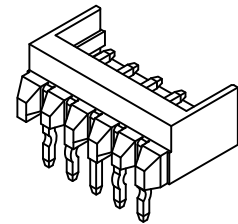

P.C.B LAYOUT

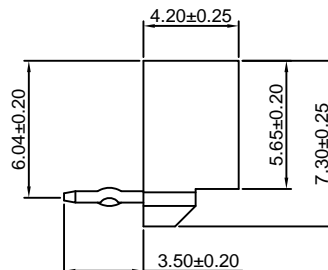
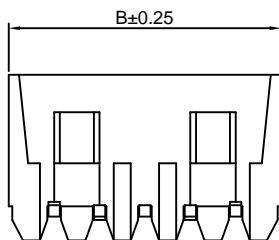

**Ordering Information & Dimensions:**

PART NO.	Dimensions	
	A	B
2P	2.00	6.00
3P	4.00	8.00
4P	6.00	10.00
5P	8.00	12.00
6P	10.00	14.00
7P	12.00	16.00
8P	14.00	18.00
9P	16.00	20.00
10P	18.00	22.00
11P	20.00	24.00
12P	22.00	26.00
13P	24.00	28.00
14P	26.00	30.00
15P	28.00	32.00

Unit: mm

### A2010WV-F-XP

2.00mm Pitch 180° Wafer

**Reference Informations:**

- \*Material:Pin:Brass/Tin over Nickel  
Insulator:Nylon 66+30%GF,UL94V-0
- \*Mates with CJT A2010H-XP series Housing
- \*Color:White

**Ordering Information:**

A2010WV-F-XP - \*\*\* - \*\*  
1 2 3

- 1.Part No.
- 2.Material:  
(Blank):Nylon 66+30%GF,UL94V-0  
GWT:Nylon 66,UL94V-0,GWT 750 °C
- 3.Color:  
(Blank):White  
BK:Black  
RD:Red  
YL:Yellow  
BL:Blue  
GN:Green

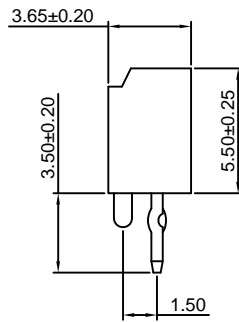
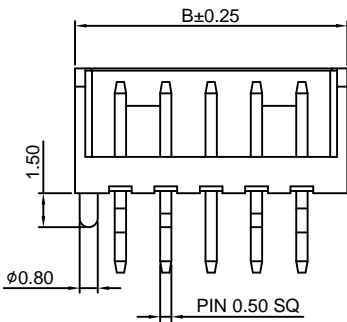
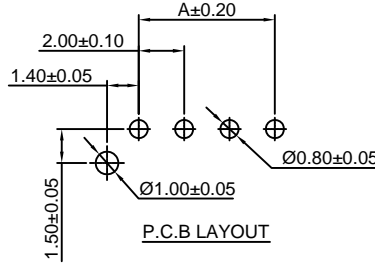
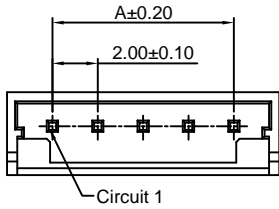

**Ordering Information & Dimensions:**

PART NO.	Dimensions	
	A	B
2P	2.00	6.00
3P	4.00	8.00
4P	6.00	10.00
5P	8.00	12.00
6P	10.00	14.00
7P	12.00	16.00
8P	14.00	18.00
9P	16.00	20.00
10P	18.00	22.00
11P	20.00	24.00
12P	22.00	26.00
13P	24.00	28.00
14P	26.00	30.00
15P	28.00	32.00

Unit: mm

### A2010WVA-F-2xXP

2.00mm Pitch 180° Dual Row Wafer

**Reference Informations:**

- \*Material:Pin:Brass/Tin over Nickel  
Insulator:Nylon 66,UL94V-0
- \*Mates with CJT A2010HA-2xXP series Dual Row Housing
- \*Color:Gray

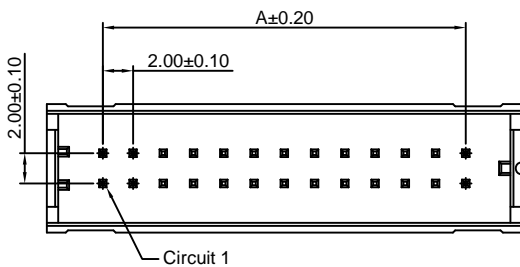
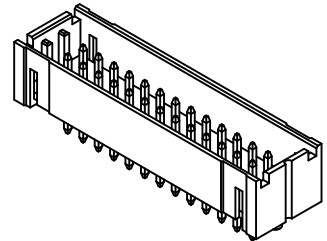
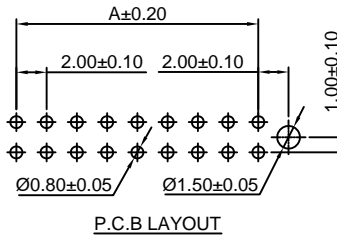

**Ordering Information:**  
A2010WVA-F-2xXP - \*\*\*  
1 2

- 1.Part No.
- 2.Material:  
(Blank):Nylon 66,UL94V-0  
GWT:Nylon 66,UL94V-0,GWT 750 °C

**Ordering Information & Dimensions:**

PART NO.	Dimensions	
	A	B
2x2P	2.00	9.40
2x3P	4.00	11.40
2x4P	6.00	13.40
2x5P	8.00	15.40
2x6P	10.00	17.40
2x7P	12.00	19.40
2x8P	14.00	21.40
2x9P	16.00	23.40
2x10P	18.00	25.40
2x11P	20.00	27.40
2x12P	22.00	29.40
2x13P	24.00	31.40
2x14P	26.00	33.40
2x15P	28.00	35.40
2x16P	30.00	37.40
2x17P	32.00	39.40
2x20P	38.00	45.40
2x25P	48.00	55.40
2x30P	58.00	65.40

Unit: mm

