

# 1MHz, 45 $\mu$ A, CMOS, Rail-to-Rail OPERATIONAL AMPLIFIERS

## FEATURES

- **LOW  $I_Q$ :** 45 $\mu$ A typical
- **LOW COST**
- **RAIL-TO-RAIL INPUT AND OUTPUT**
- **SINGLE SUPPLY:** +2.1V to +5.5V
- **INPUT BIAS CURRENT:** 0.5pA
- **MicroSIZE PACKAGES:** SC70-5, SOT23-8 and TSSOP-14
- **HIGH SPEED:POWER WITH BANDWIDTH:** 1MHz

## APPLICATIONS

- **PORTABLE EQUIPMENT**
- **BATTERY-POWERED EQUIPMENT**
- **SMOKE ALARMS**
- **CO DETECTORS**
- **MEDICAL INSTRUMENTATION**

## DESCRIPTION

The OPA348 series amplifiers are single supply, low-power, CMOS op amps in micro packaging. Featuring an extended bandwidth of 1MHz, and a supply current of 45 $\mu$ A, the OPA348 series is useful for low-power applications on single supplies of 2.1V to 5.5V.

Low supply current of 45 $\mu$ A, and an input bias current of 0.5pA, make the OPA348 series an optimal candidate for low-power, high-impedance applications such as smoke detectors and other sensors.

The OPA348 is available in the miniature SC70-5, SOT23-5 and SO-8 packages. The OPA2348 is available in SOT23-8 and SO-8 packages, and the OPA4348 is offered in space-saving TSSOP-14 and SO-14 packages. The extended temperature range of  $-40^{\circ}\text{C}$  to  $+125^{\circ}\text{C}$  over all supply voltages offers additional design flexibility.

## Pin Assignment

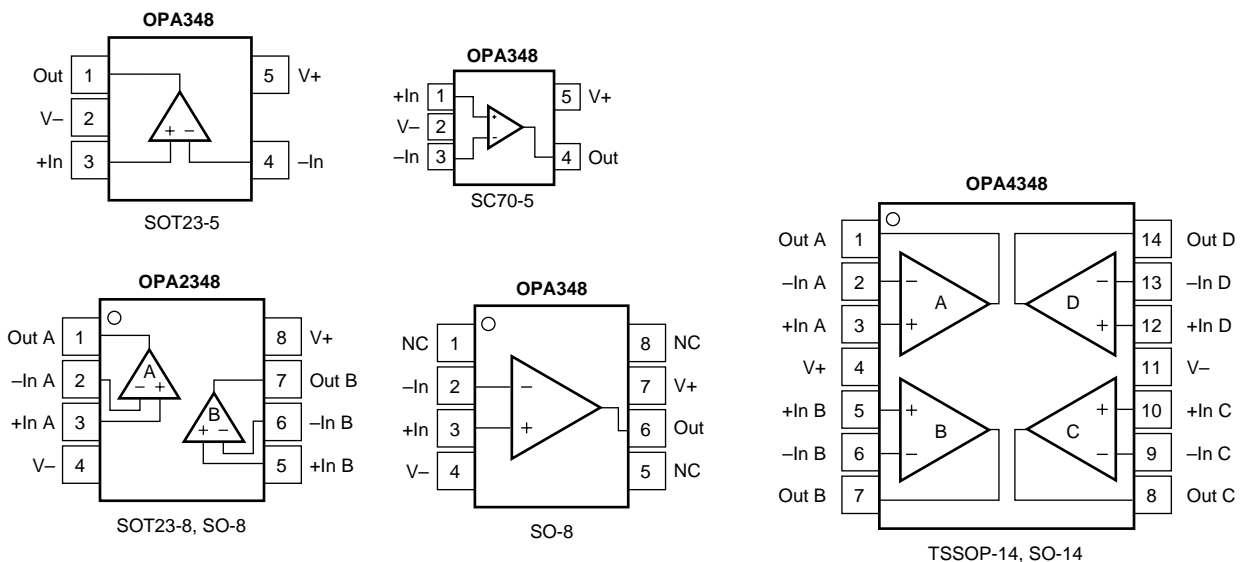

**ABSOLUTE MAXIMUM RATINGS<sup>(1)</sup>**

Supply Voltage, V- to V+ .....	7.5V
Signal Input Terminals, Voltage <sup>(2)</sup> .....	(V-) - 0.5V to (V+) + 0.5V
Current <sup>(2)</sup> .....	10mA
Output Short-Circuit <sup>(3)</sup> .....	Continuous
Operating Temperature .....	-65°C to +150°C
Storage Temperature .....	-65°C to +150°C
Junction Temperature .....	150°C
Lead Temperature (soldering, 10s) .....	300°C

NOTES: (1) Stresses above these ratings may cause permanent damage. Exposure to absolute maximum conditions for extended periods may degrade device reliability. These are stress ratings only. Functional operation of the device at these conditions, or beyond the specified operating conditions, is not implied. (2) Input terminals are diode-clamped to the power-supply rails. Input signals that can swing more than 0.5V beyond the supply rails should be current-limited to 10mA or less. (3) Short-circuit to ground, one amplifier per package.

**ELECTROSTATIC DISCHARGE SENSITIVITY**

This integrated circuit can be damaged by ESD. Texas Instruments recommends that all integrated circuits be handled with appropriate precautions. Failure to observe proper handling and installation procedures can cause damage.

ESD damage can range from subtle performance degradation to complete device failure. Precision integrated circuits may be more susceptible to damage because very small parametric changes could cause the device not to meet its published specifications.

**ELECTRICAL CHARACTERISTICS:  $V_S = 2.5V$  to  $5.5V$**

**Boldface** limits apply over the specified temperature range,  $T_A = -40^{\circ}C$  to  $+125^{\circ}C$

At  $T_A = +25^{\circ}C$ ,  $R_L = 100k\Omega$  connected to  $V_S/2$  and  $V_{OUT} = V_S/2$ , unless otherwise noted.

PARAMETER	CONDITION	OPA348 OPA2348 OPA4348			UNITS
		MIN	TYP	MAX	
<b>OFFSET VOLTAGE</b> Input Offset Voltage <b>Over Temperature</b> Drift vs Power Supply <b>Over Temperature</b> Channel Separation, dc $f = 1kHz$	$V_{OS}$ $V_S = 5V, V_{CM} = (V-) + 0.8V$  $dV_{OS}/dT$ PSRR $V_S = 2.5V$ to $5.5V, V_{CM} < (V+) - 1.7V$ <b><math>V_S = 2.5V</math> to <math>5.5V, V_{CM} &lt; (V+) - 1.7V</math></b>		1  4 60 0.2 134	5 <b>6</b>  175 <b>300</b>	mV mV $\mu V/^{\circ}C$ $\mu V/V$ $\mu V/V$ dB
<b>INPUT VOLTAGE RANGE</b> Common-Mode Voltage Range Common-Mode Rejection Ratio <b>over Temperature</b>  <b>over Temperature</b>	$V_{CM}$ CMRR $(V-) - 0.2V < V_{CM} < (V+) - 1.7V$ <b><math>(V-) &lt; V_{CM} &lt; (V+) - 1.7V</math></b> $V_S = 5.5V, (V-) - 0.2V < V_{CM} < (V+) + 0.2V$ <b><math>V_S = 5.5V, (V-) &lt; V_{CM} &lt; (V+)</math></b>	$(V-) - 0.2$ 70 <b>66</b> 60 <b>56</b>	82  71	$(V+) + 0.2$	V dB dB dB dB
<b>INPUT BIAS CURRENT</b> Input Bias Current Input Offset Current	$I_B$ $I_{OS}$		$\pm 0.5$ $\pm 0.5$	$\pm 10$ $\pm 10$	pA pA
<b>INPUT IMPEDANCE</b> Differential Common-Mode			$10^{13} \parallel 3$ $10^{13} \parallel 6$		$\Omega \parallel pF$ $\Omega \parallel pF$
<b>NOISE</b> Input Voltage Noise, $f = 0.1Hz$ to $10Hz$ Input Voltage Noise Density, $f = 1kHz$ Input Current Noise Density, $f = 1kHz$	$V_{CM} < (V+) - 1.7V$  $e_n$ $i_n$		10 35 4		$\mu Vp-p$ $nV/\sqrt{Hz}$ $fA/\sqrt{Hz}$
<b>OPEN-LOOP GAIN</b> Open-Loop Voltage Gain <b>over Temperature</b>  <b>over Temperature</b>	$A_{OL}$ $V_S = 5V, R_L = 100k\Omega, 0.025V < V_O < 4.975V$ <b><math>V_S = 5V, R_L = 100k\Omega, 0.025V &lt; V_O &lt; 4.975V</math></b> $V_S = 5V, R_L = 5k\Omega, 0.125V < V_O < 4.875V$ <b><math>V_S = 5V, R_L = 5k\Omega, 0.125V &lt; V_O &lt; 4.875V</math></b>	94 <b>90</b> 90 <b>88</b>	108  98		dB dB dB dB
<b>OUTPUT</b> Voltage Output Swing from Rail <b>over Temperature</b>  <b>over Temperature</b> Short-Circuit Current Capacitive Load Drive	$I_{SC}$ $C_{LOAD}$ $R_L = 100k\Omega, A_{OL} > 94dB$ <b><math>R_L = 100k\Omega, A_{OL} &gt; 90dB</math></b> $R_L = 5k\Omega, A_{OL} > 90dB$ <b><math>R_L = 5k\Omega, A_{OL} &gt; 88dB</math></b>		18 100 $\pm 10$	25 125 <b>125</b>	mV mV mV mV mA
<b>FREQUENCY RESPONSE</b> Gain-Bandwidth Product Slew Rate Settling Time, 0.1% 0.01% Overload Recovery Time Total Harmonic Distortion + Noise	$C_L = 100pF$  GBW SR $t_S$ $V_S = 5.5V, 2V$ Step, $G = +1$ $V_S = 5.5V, 2V$ Step, $G = +1$ $V_{IN} \cdot Gain > V_S$ THD+N $V_S = 5.5V, V_O = 3Vp-p, G = +1, f = 1kHz$		1 0.5 5 7 1.6 0.0023		MHz V/ $\mu s$ $\mu s$ $\mu s$ $\mu s$ %
<b>POWER SUPPLY</b> Specified Voltage Range Minimum Operating Voltage Quiescent Current (per amplifier) <b>over Temperature</b>	$V_S$  $I_Q$ $I_Q = 0$	2.5	2.1 to 5.5 45	5.5 65 <b>75</b>	V V $\mu A$ $\mu A$
<b>TEMPERATURE RANGE</b> Specified Range Operating Range Storage Range Thermal Resistance SOT23-5 Surface-Mount SOT23-8 Surface-Mount MSOP-8 Surface-Mount SO-8 Surface-Mount SO-14 Surface-Mount TSSOP-14 Surface-Mount SC70-5 Surface-Mount	$\theta_{JA}$	-40 -65 -65		125 150 150  200 150 150 150 100 100 250	$^{\circ}C$ $^{\circ}C$ $^{\circ}C$ $^{\circ}C/W$ $^{\circ}C/W$ $^{\circ}C/W$ $^{\circ}C/W$ $^{\circ}C/W$ $^{\circ}C/W$ $^{\circ}C/W$ $^{\circ}C/W$

## TYPICAL CHARACTERISTICS

At  $T_A = +25^\circ\text{C}$ ,  $R_L = 100\text{k}\Omega$  connected to  $V_S/2$  and  $V_{OUT} = V_S/2$ , unless otherwise noted.

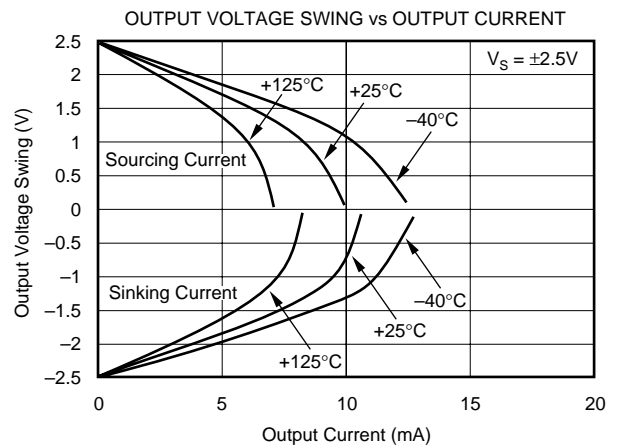
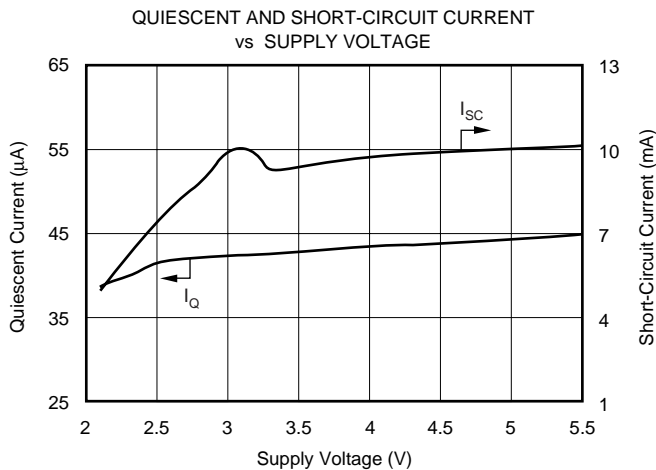
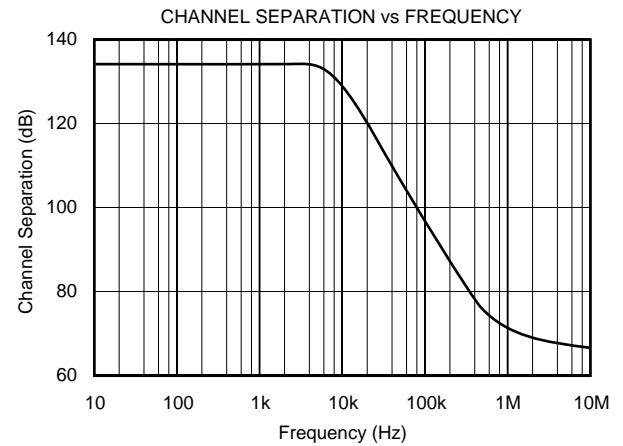
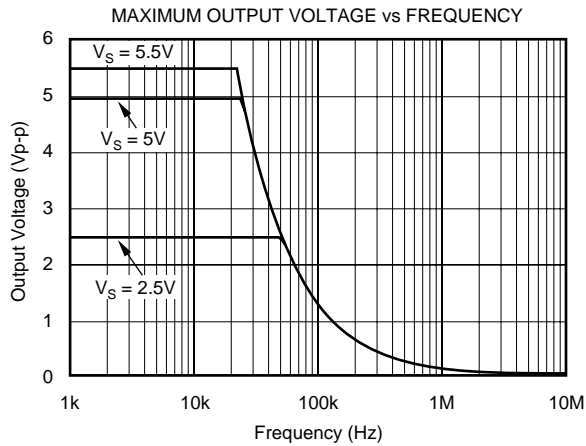
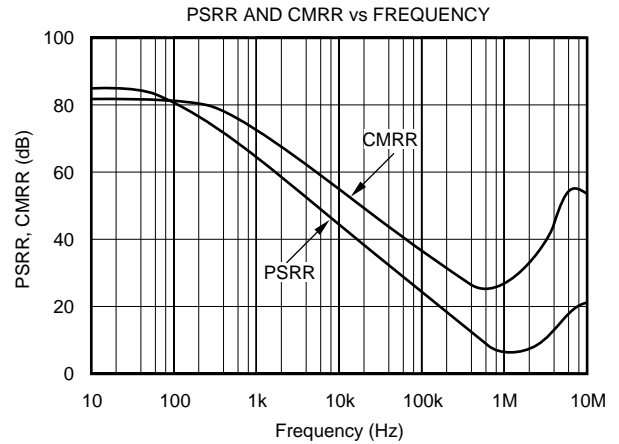
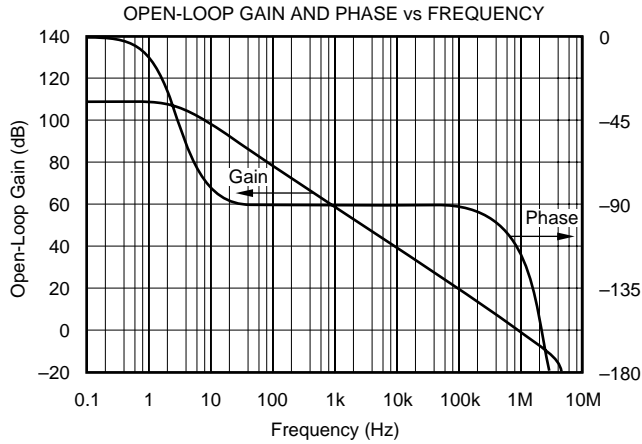

## TYPICAL CHARACTERISTICS (Cont.)

At  $T_A = +25^\circ\text{C}$ ,  $R_L = 100\text{k}\Omega$  connected to  $V_S/2$  and  $V_{OUT} = V_S/2$ , unless otherwise noted.

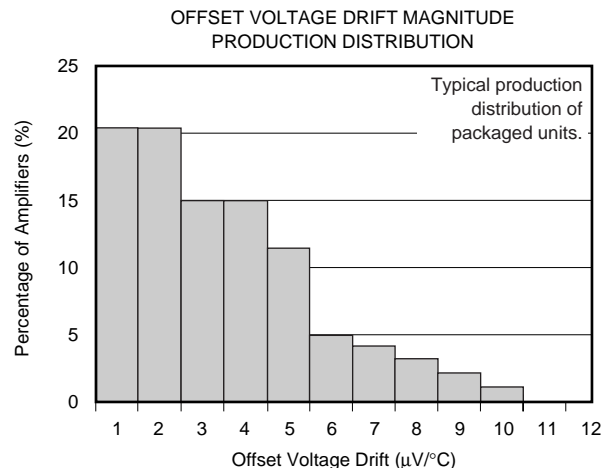
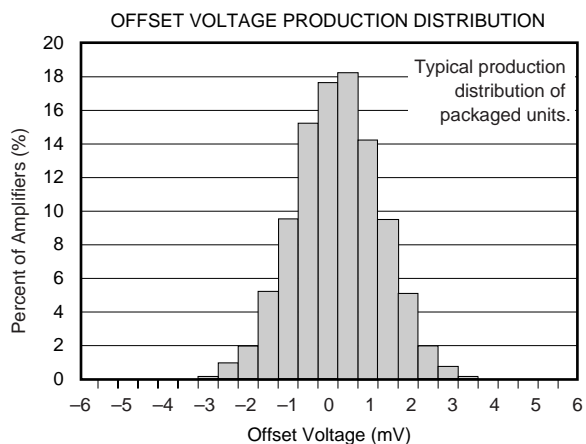
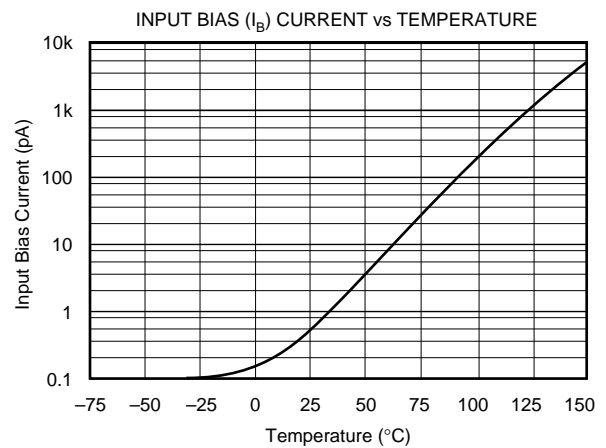
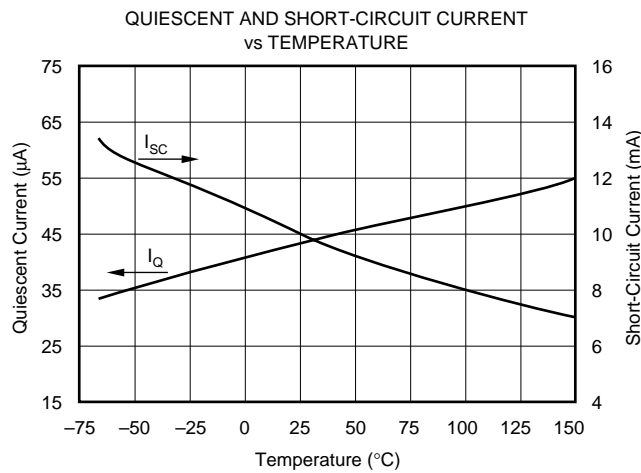
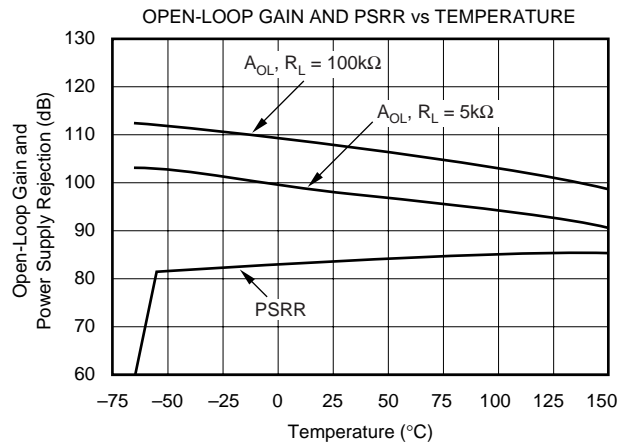
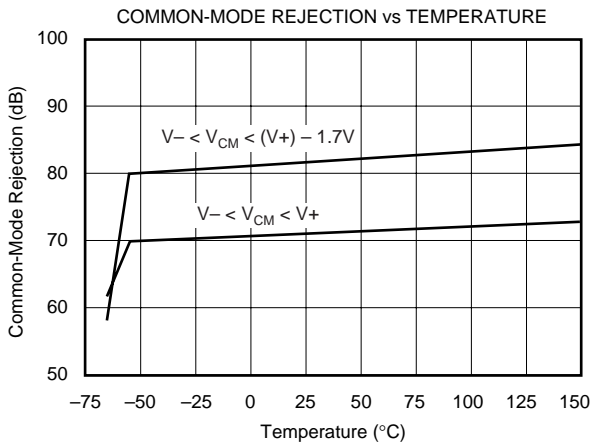

## TYPICAL CHARACTERISTICS (Cont.)

At  $T_A = +25^\circ\text{C}$ ,  $R_L = 100\text{k}\Omega$  connected to  $V_S/2$  and  $V_{OUT} = V_S/2$ , unless otherwise noted.

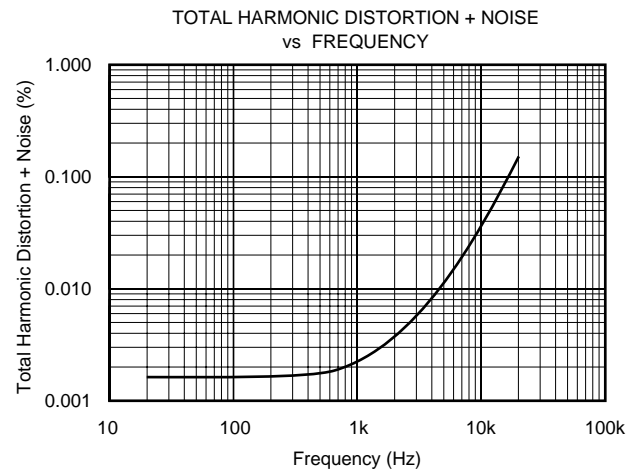
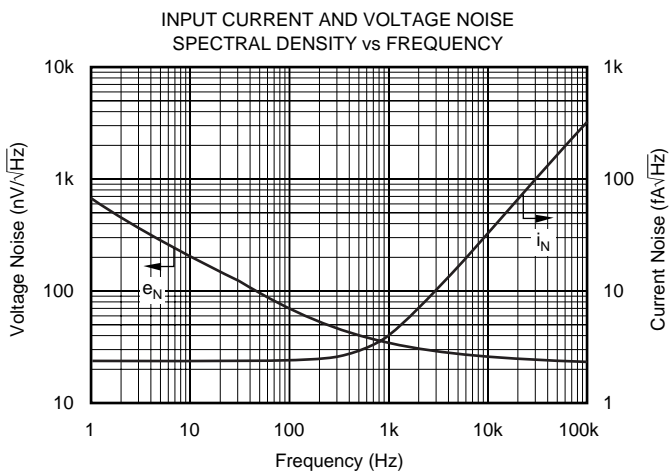
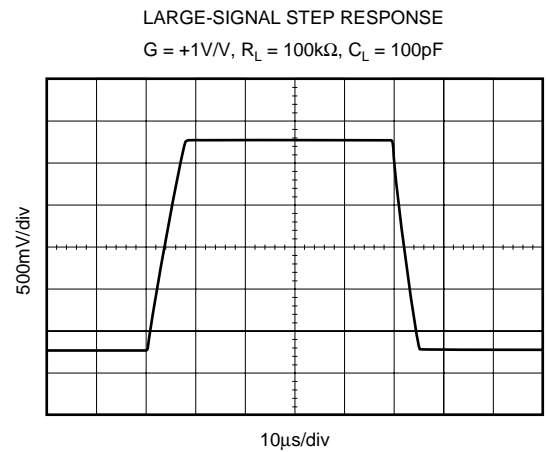
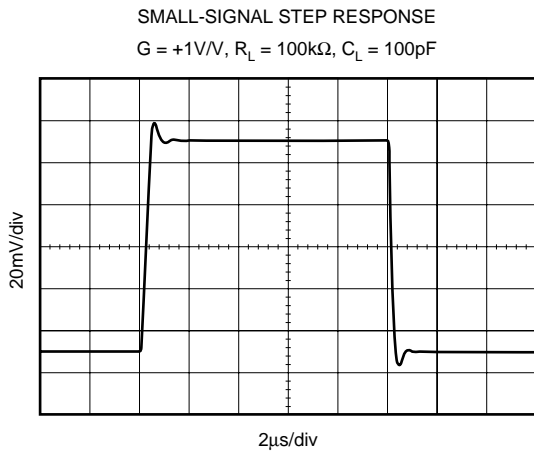
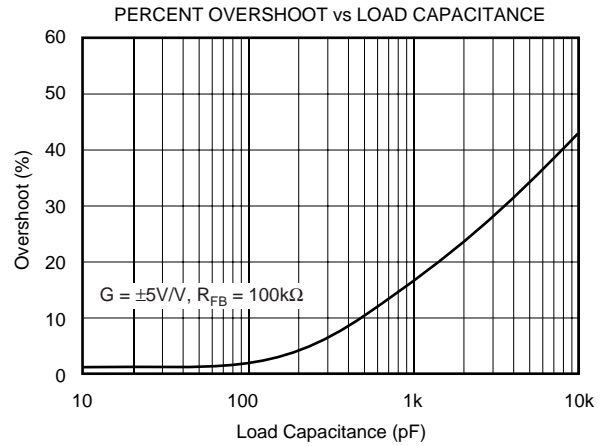
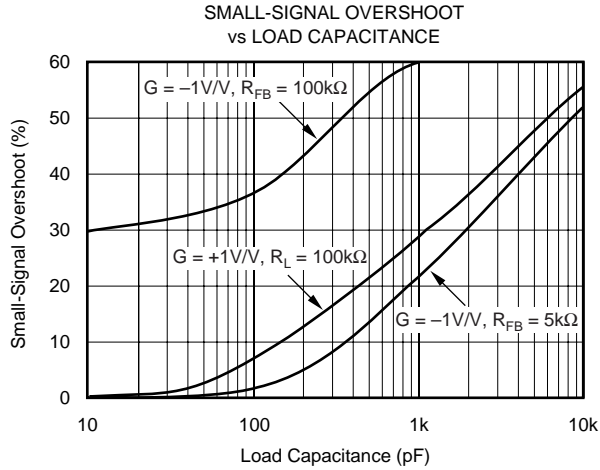

## APPLICATIONS INFORMATION

OPA348 series op amps are unity-gain stable and suitable for a wide range of general-purpose applications.

The OPA348 series features wide bandwidth and unity-gain stability with rail-to-rail input and output for increased dynamic range. Figure 1 shows the input and output waveforms for the OPA348 in unity-gain configuration. Operation is from a single +5V supply with a 100kΩ load connected to  $V_S/2$ . The input is a 5Vp-p sinusoid. Output voltage is approximately 4.98Vp-p.

Power-supply pins should be bypassed with 0.01μF ceramic capacitors.

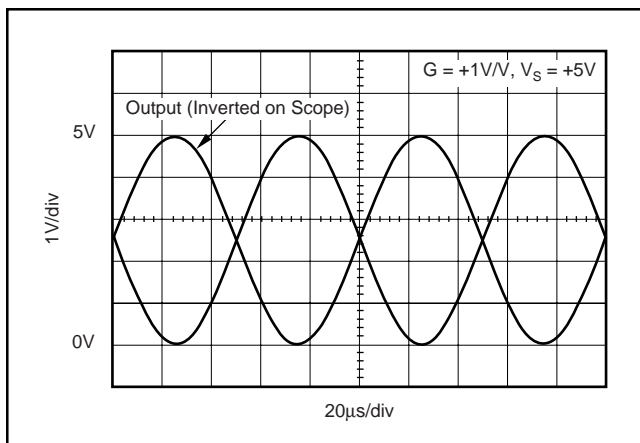

FIGURE 1. The OPA348 Features Rail-to-Rail Input/Output.

### OPERATING VOLTAGE

OPA348 series op amps are fully specified and tested from +2.5V to +5.5V. However, supply voltage may range from +2.1V to +5.5V. Parameters are tested over the specified supply range—a unique feature of the OPA348 series. In addition, all temperature specifications apply from  $-40^{\circ}\text{C}$  to  $+125^{\circ}\text{C}$ . Most behavior remains virtually unchanged throughout the full operating voltage range. Parameters that vary significantly with operating voltages or temperature are shown in the Typical Characteristics.

### COMMON-MODE VOLTAGE RANGE

The input common-mode voltage range of the OPA348 series extends 200mV beyond the supply rails. This is achieved with a complementary input stage—an N-channel input differential pair in parallel with a P-channel differential pair. The N-channel pair is active for input voltages close to the positive rail, typically  $(V_+) - 1.2\text{V}$  to 300mV above the positive supply, while the P-channel pair is on for inputs from 300mV below the negative supply to approximately  $(V_+) - 1.4\text{V}$ . There is a small transition region, typically  $(V_+) - 1.4\text{V}$  to  $(V_+) - 1.2\text{V}$ , in which both pairs are on. This 200mV transition region, shown in Figure 2, can vary  $\pm 300\text{mV}$  with process variation. Thus, the transition region (both stages on) can range from  $(V_+) - 1.7\text{V}$  to  $(V_+) - 1.5\text{V}$  on the low end, up to  $(V_+) - 1.1\text{V}$  to  $(V_+) - 0.9\text{V}$

on the high end. Within the 200mV transition region PSRR, CMRR, offset voltage, offset drift, and THD may be degraded compared to operation outside this region.

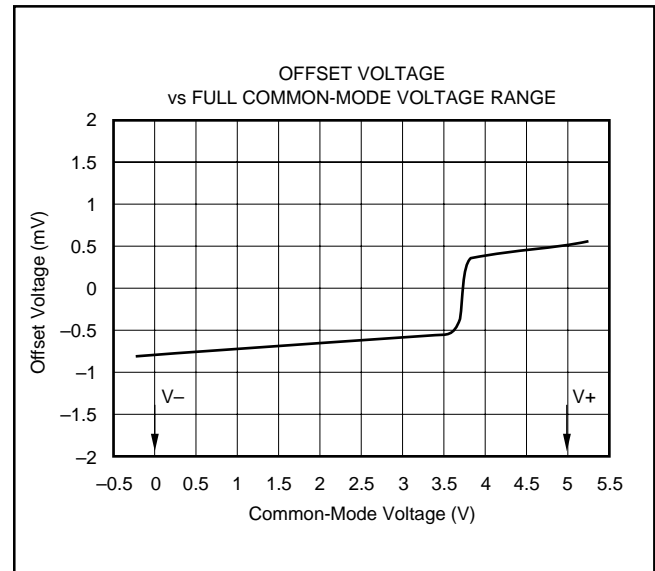

FIGURE 2. Behavior of Typical Transition Region at Room Temperature.

### RAIL-TO-RAIL INPUT

The input common-mode range extends from  $(V_-) - 0.2\text{V}$  to  $(V_+) + 0.2\text{V}$ . For normal operation, inputs should be limited to this range. The absolute maximum input voltage is 500mV beyond the supplies. Inputs greater than the input common-mode range but less than the maximum input voltage, while not valid, will not cause any damage to the op amp. Unlike some other op amps, if input current is limited the inputs may go beyond the power supplies without phase inversion, as shown in Figure 3.

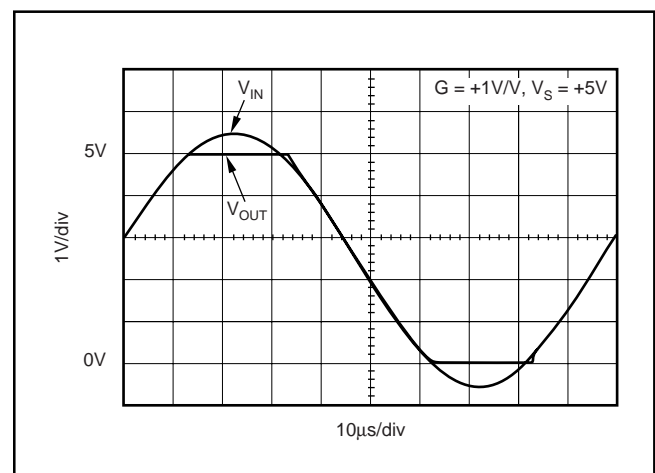

FIGURE 3. OPA348—No Phase Inversion with Inputs Greater than the Power-Supply Voltage.

Normally, input currents are 0.5pA. However, large inputs (greater than 500mV beyond the supply rails) can cause excessive current to flow in or out of the input pins. Therefore, as well as keeping the input voltage below the maximum rating, it is also important to limit the input current to less than 10mA. This is easily accomplished with an input voltage resistor, as shown in Figure 4.

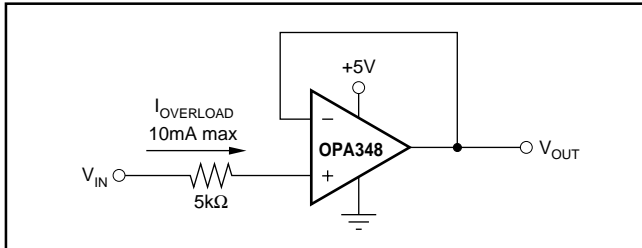

FIGURE 4. Input Current Protection for Voltages Exceeding the Supply Voltage.

### RAIL-TO-RAIL OUTPUT

A class AB output stage with common-source transistors is used to achieve rail-to-rail output. This output stage is capable of driving 5kΩ loads connected to any potential between V+ and ground. For light resistive loads (> 100kΩ), the output voltage can typically swing to within 18mV from supply rail. With moderate resistive loads (10kΩ to 50kΩ), the output voltage can typically swing to within 100mV of the supply rails while maintaining high open-loop gain (see the typical characteristic “Output Voltage Swing vs Output Current”).

### CAPACITIVE LOAD AND STABILITY

The OPA348 in a unity-gain configuration can directly drive up to 250pF pure capacitive load. Increasing the gain enhances the amplifier’s ability to drive greater capacitive loads (see the typical characteristic “Small-Signal Overshoot vs Capacitive Load”). In unity-gain configurations, capacitive load drive can be improved by inserting a small (10Ω to 20Ω) resistor,  $R_S$ , in series with the output, as shown in Figure 5. This significantly reduces ringing while maintaining DC performance for purely capacitive loads. However, if there is a resistive load in parallel with the capacitive load, a voltage divider is created, introducing a Direct Current (DC) error at the output and slightly reducing the output swing. The error introduced is proportional to the ratio  $R_S/R_L$ , and is generally negligible.

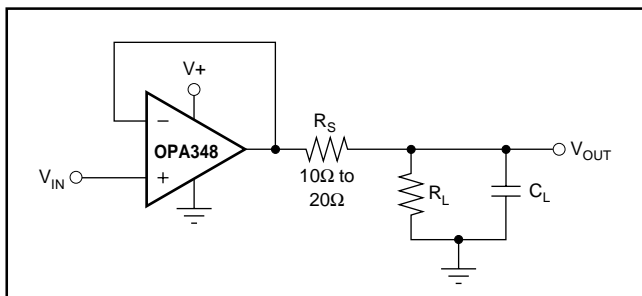

FIGURE 5. Series Resistor in Unity-Gain Buffer Configuration Improves Capacitive Load Drive.

In unity-gain inverter configuration, phase margin can be reduced by the reaction between the capacitance at the op amp input, and the gain setting resistors, thus degrading capacitive load drive. Best performance is achieved by using small valued resistors. For example, when driving a 500pF load, reducing the resistor values from 100kΩ to 5kΩ decreases overshoot from 55% to 13% (see the typical characteristic “Small-Signal Overshoot vs. Load Capacitance”). However, when large valued resistors cannot be avoided, a small (4pF to 6pF) capacitor,  $C_{FB}$ , can be inserted in the feedback, as shown in Figure 6. This significantly reduces overshoot by compensating the effect of capacitance,  $C_{IN}$ , which includes the amplifier’s input capacitance and PC board parasitic capacitance.

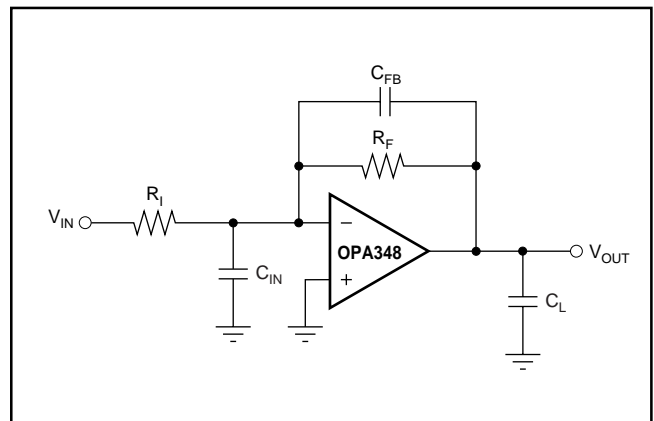

FIGURE 6. Improving Capacitive Load Drive.

### DRIVING A/D CONVERTERS

The OPA348 series op amps are optimized for driving medium-speed sampling Analog-to-Digital Converters (ADCs). The OPA348 op amps buffer the ADCs input capacitance and resulting charge injection while providing signal gain.

The OPA348 in a basic noninverting configuration driving the ADS7822, see Figure 7. The ADS7822 is a 12-bit, *micro*POWER sampling converter in the MSOP-8 package. When used with the low-power, miniature packages of the OPA348, the combination is ideal for space-limited, low-power applications. In this configuration, an RC network at the ADC’s input can be used to provide for anti-aliasing filter and charge injection current.

The OPA348 in noninverting configuration driving ADS7822 limited, low-power applications. In this configuration, an RC network at the ADC’s input can be used to provide for anti-aliasing filter and charge injection current. See Figure 8 for the OPA2348 driving an ADS7822 in a speech bandpass filtered data acquisition system. This small, low-cost solution provides the necessary amplification and signal conditioning to interface directly with an electret microphone. This circuit will operate with  $V_S = 2.7V$  to 5V with less than 250μA typical quiescent current.



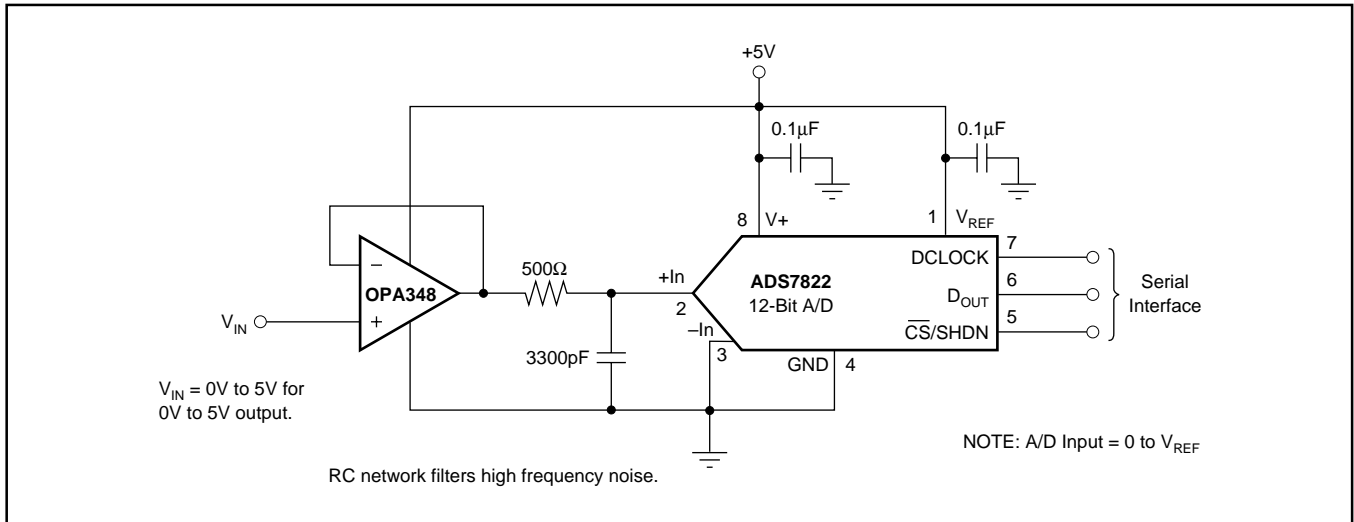

FIGURE 7. OPA348 in Noninverting Configuration Driving ADS7822.

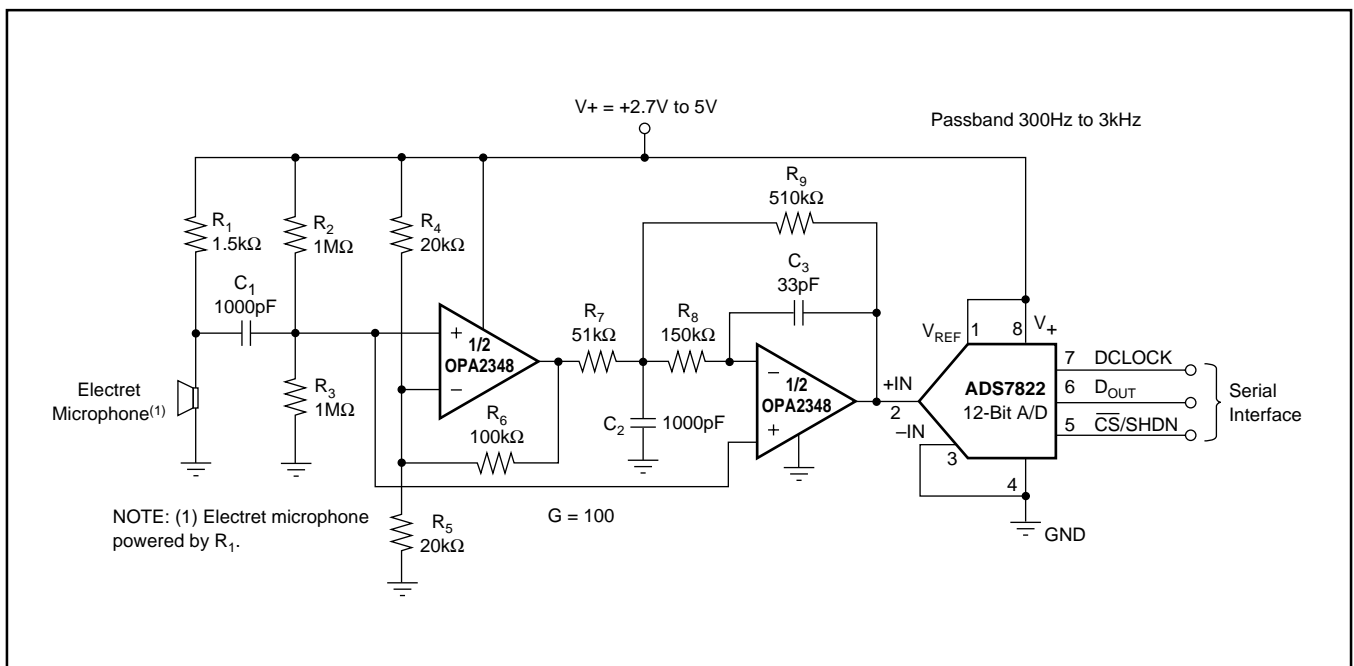

FIGURE 8. OPA2348 as a Speech Bandpass Filtered Data Acquisition System.

### Important statement:

Huaguan Semiconductor Co,Ltd. reserves the right to change the products and services provided without notice. Customers should obtain the latest relevant information before ordering, and verify the timeliness and accuracy of this information.

Customers are responsible for complying with safety standards and taking safety measures when using our products for system design and machine manufacturing to avoid potential risks that may result in personal injury or property damage.

Our products are not licensed for applications in life support, military, aerospace, etc., so we do not bear the consequences of the application of these products in these fields.

Our documentation is only permitted to be copied without any tampering with the content, so we do not accept any responsibility or liability for the altered documents.