

## DIO2352A/B

### Ultra Low Vos, 2.5kHz, RRIO CMOS High-Precision Amplifier

#### Features

- Rail-to-Rail Input and Output
- Low offset ( $V_{OS}$ ):  $\pm 13\mu V$
- Gain Error:  $\pm 1\%$
- Input offset drift:  $0.01\mu V/^{\circ}C$ (Max)
- Gain drift:  $10\text{ppm}/^{\circ}C$ (Max)
- Gain Selection:
  - DIO2352A: 50V/V
  - DIO2352B: 100V/V
- Wide supply range: 2.5V to 5.5V
- Single Supply Operation
- Quiescent Current:  $730\mu A$ (Typ)
- Available Packages: SOIC-8, TSSOP-8, DFN-8

#### Applications

- Notebook Computer
- Mobile Phone
- Power Management IC
- Battery Charger
- Welding Equipment

#### Descriptions

The DIO2352X is an ultra-low offset voltage rail-to-rail input and output voltage feedback amplifier. They have a wide input common-mode voltage range and output voltage swing, and take the operating supply voltage is from 2.5 to 5.5V.

The DIO2352X features an offset voltage of only  $13\mu V$  and drift of  $0.01\mu V/^{\circ}C$ , which makes the product perfect in applications of intolerant errors. Temperature/position/pressure sensors and medical equipment can benefit greatly from nearly zero drift over their operating temperature range.

#### Typical Application

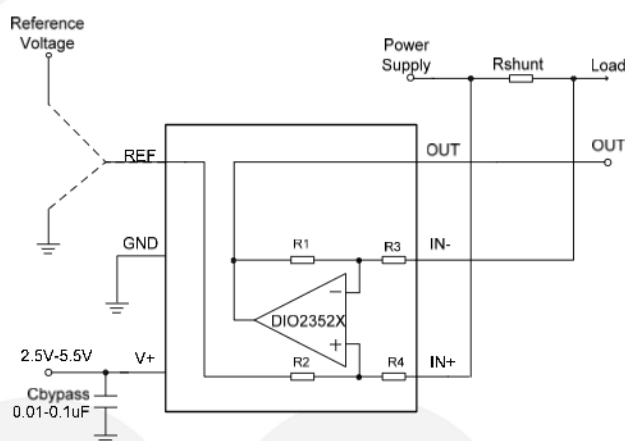

#### Ordering Information

Order Part Number	Top Marking		$T_A$	Package	
DIO2352ASO8	DIO2352A	Green/RoHS	-40 to +125 $^{\circ}C$	SOIC-8	Tape & Reel, 2500
DIO2352BSO8	DIO2352B	Green/RoHS	-40 to +125 $^{\circ}C$	SOIC-8	Tape & Reel, 2500
DIO2352ATP8	DIO2352A	Green/RoHS	-40 to +125 $^{\circ}C$	TSSOP-8	Tape & Reel, 3000
DIO2352BTP8	DIO2352B	Green/RoHS	-40 to +125 $^{\circ}C$	TSSOP-8	Tape & Reel, 3000
DIO2352AED8	23A	Green/RoHS	-40 to +125 $^{\circ}C$	DFN-8	Tape & Reel, 3000
DIO2352BED8	23B	Green/RoHS	-40 to +125 $^{\circ}C$	DFN-8	Tape & Reel, 3000

## Pin Assignments

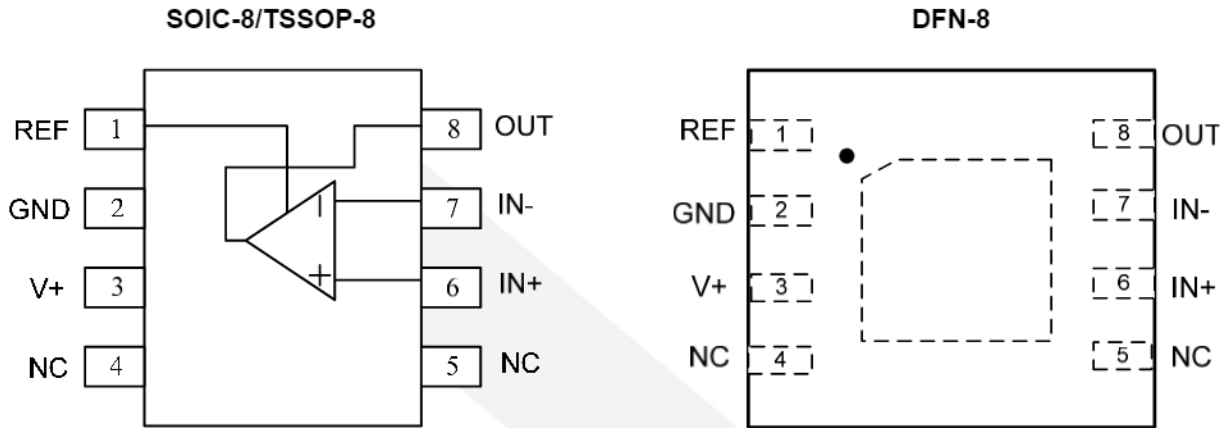

Figure 1 Pin Assignment

## Pin Description

Pin name	Description
V+	Positive supply
GND	Negative supply
IN+	Positive Input
IN-	Negative Input
OUT	Output
REF	Reference Input
NC	No connect

## Absolute Maximum Ratings

Stresses beyond those listed under "Absolute Maximum Rating" may cause permanent damage to the device. These are stress ratings only and functional operation of the device at these or any other condition beyond those indicated in the operational sections of the specifications is not implied. Exposure to absolute maximum rating conditions for extended periods may affect device reliability.

Parameter		Rating	Unit
Supply Voltage		7.5	V
Input Voltage		$(-V_S)-0.5$ to $(+V_S)+0.5V$	V
Storage Temperature Range		-65 to 150	°C
Junction Temperature		150	°C
Lead Temperature Range		260	°C
ESD	HBM, JEDEC: JESD22-A114	8	kV
	CDM, JEDEC: JESD22-C101	2	

## Recommended Operating Conditions

The Recommended Operating Conditions table defines the conditions for actual device operation to ensure optimal performance to the datasheet specifications. DIOO does not recommend exceeding them or designing to Absolute Maximum Ratings.

Parameter		Rating	Unit
Supply Voltage		2.5 to 5.5	V
Input Voltage		0 to 5	V
Operating Temperature Range		-40 to 125	°C



## Electrical Characteristics

$V_{+}=+5V$ ,  $V_{REF}=V_S/2$ ,  $T_A = 25^{\circ}C$ , unless otherwise specified.

Symbol	Parameter	Conditions	Min.	Typ.	Max.	Unit
<b>INPUT CHARACTERISTICS</b>						
$V_{CM}$	Common Mode Input Current		-0.1		(V+)+ 0.1	V
CMRR	Common Mode Rejection Ratio	$V_{CM}=-0.1$ to (V+)+0.1		100		dB
$V_{OS}$	Input Offset Voltage	Common voltage= $V_S$	-80	30	+80	$\mu V$
		Common voltage= $V_S/2$	-20	13	20	
PSRR	Power Supply Rejection Ration	$V_S=2.7V$ to 5.5V		100		dB
$I_B$	Input Bias Current			5		$\mu A$
$I_{OS}$	Input Offset Current			20		pA
$\Delta V_{OS}/\Delta T$	Input Offset Voltage Drift	$-40^{\circ}C \leq T_A \leq 125^{\circ}C$		0.01		$\mu V/^{\circ}C$
	Gain Drift			3	10	ppm/ $^{\circ}C$
Gain		DIO2352A		50		V/V
		DIO2352B		100		V/V
<b>OUTPUT CHARACTERISTICS</b>						
$V_{OH}$	Output Voltage High	$R_L=100k\Omega$ , $-40^{\circ}C \leq T_A \leq 125^{\circ}C$		4.998		V
		$R_L=10k\Omega$ , $-40^{\circ}C \leq T_A \leq 125^{\circ}C$		4.99		
$V_{OL}$	Output Voltage Low	$R_L=100k\Omega$ , $-40^{\circ}C \leq T_A \leq 125^{\circ}C$		1.2		mV
		$R_L=10k\Omega$ , $-40^{\circ}C \leq T_A \leq 125^{\circ}C$		7.3		
$I_O$	Output Current	Source Current		50		mA
		Sink Current		50		
$I_S$	Supply Current	$-40^{\circ}C \leq T_A \leq 125^{\circ}C$		730		$\mu A$
GBP	Gain Bandwidth Product			2.5		kHz
<b>NOISE PERFORMANCE</b>						
THD	Total Harmonic Distortion	f=1kHz, 2V Output Step, $R_L=10k\Omega$ ,		0.0014		%
$e_n$	Voltage Noise Density	f=1kHz		40		nV/kHz

Specifications subject to change without notice.

## Typical Performance Characteristics

$V_{+}=+5V$ ,  $V_{REF}=V_S/2$ ,  $T_A = 25^{\circ}C$ , unless otherwise specified.

Supply Voltage & Current

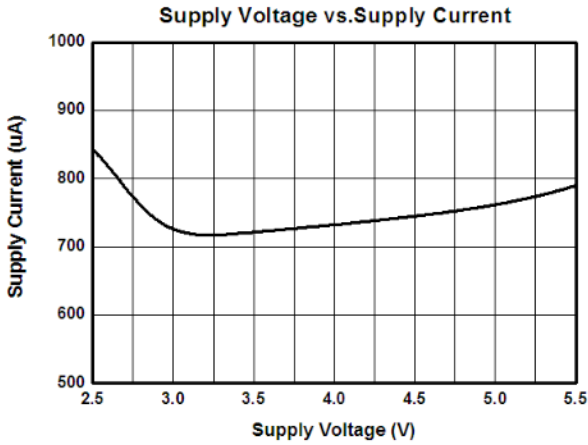

ICC & Temperature

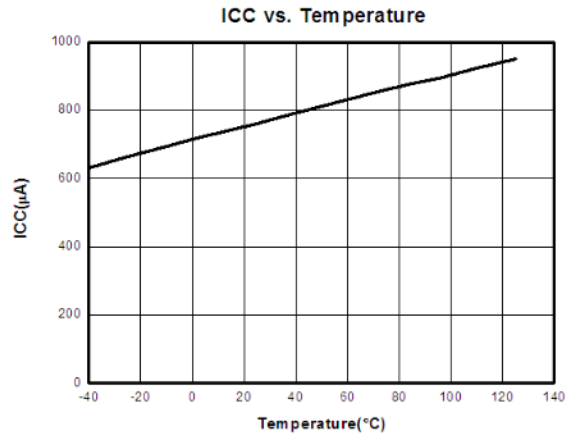

GBW & Frequency  
(G=100)

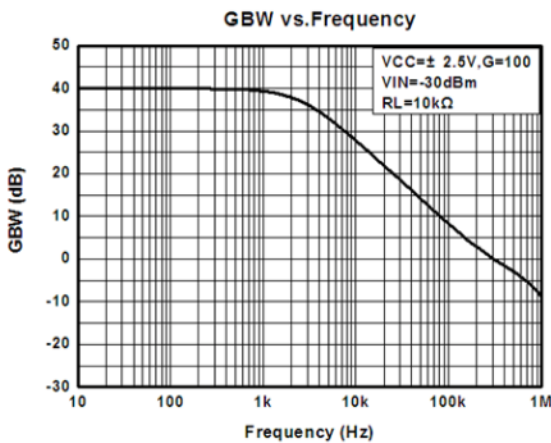

GBW & Frequency  
(G=50)

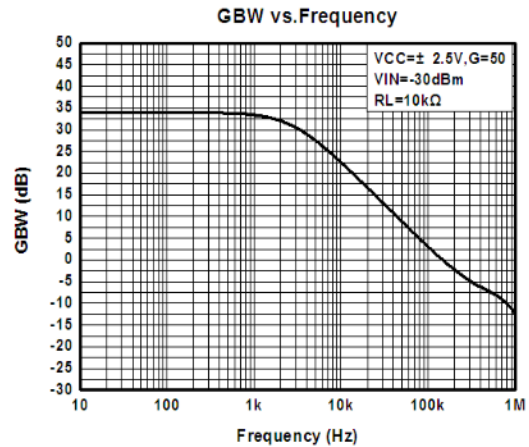

CMRR & Frequency

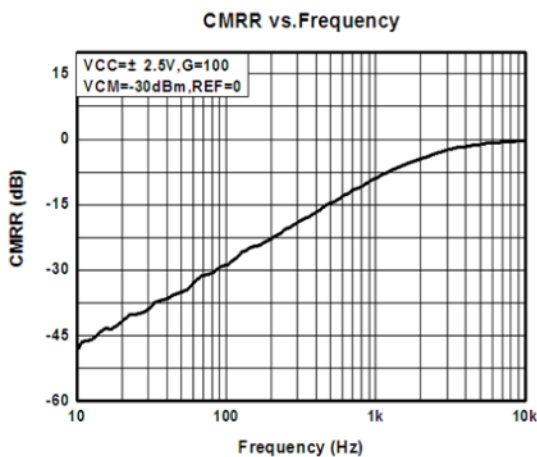

PSRR & Frequency

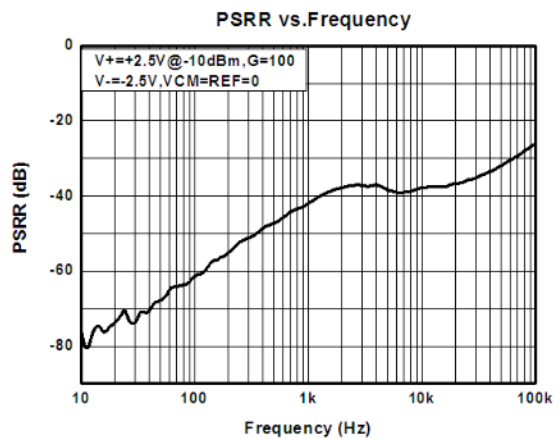

Large Signal Response

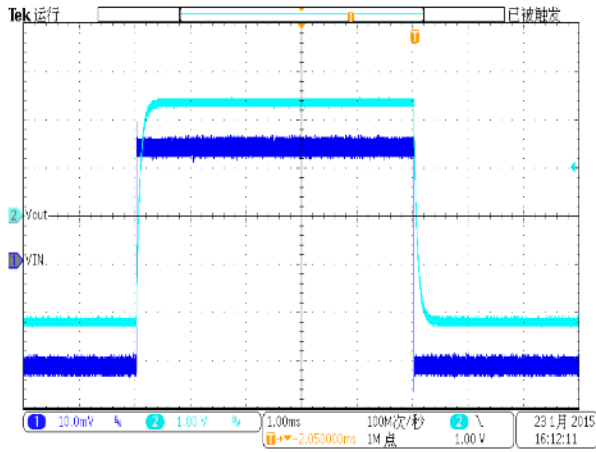

Over Load Recovery Time

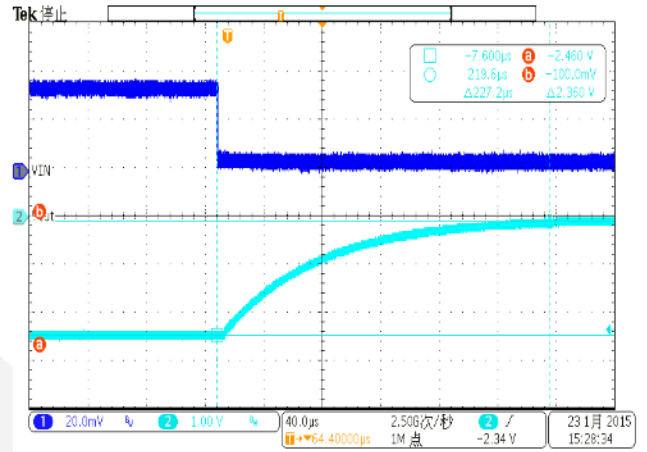

Over Load Recovery Time

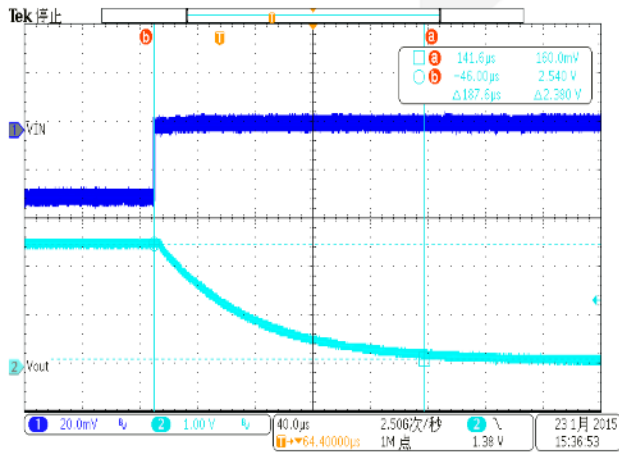

## CONTACT US

Dioo is a professional design and sales corporation for high-quality and performance analog semiconductors. The company focuses on industry markets, such as, cell phone, handheld products, laptop, and medical equipment and so on. Dioo's product families include analog signal processing and amplifying, LED drivers and charger IC. Go to <http://www.dioo.com> for a complete list of Dioo product families.

For additional product information, or full datasheet, please contact with our Sales Department or Representatives.

