

# DATA SHEET

**BONSDA CODE** : STP-1125

**DESCRIPTION** : TACT SWITCH

## SHENZHEN ZIGENG TECHNOLOGY CO.,LTD

ADDRESS D BUILDING 3TH FLOOR, ZI HENG ROAD NO. 49, KENGZI STREETS,  
PINGSHAN NEW DISTRICT, SHENZHEN, GUANGDONG PROVINCE, CHINA

TEL +86 755-84517080

FAX +86 755-27823630

E-MAIL LINSL@ZIGKJ.COM

WEBSITE WWW.ZIGKJ.COM



**BONSDA**  
ELECTRONICS

## 1. Description:

This specification covers the requirements for single key switches which have no key top (Tact switches mechanical contact).

1-1 Operating Temperature Range :  $-40^{\circ}\text{C} \sim +70^{\circ}\text{C}$  (normal humidity, normal press)

1-2 Storage Temperature Range :

1-2-1 Single Condition :  $-40^{\circ}\text{C} \sim +80^{\circ}\text{C}$

1-2-2 Taping Condition :  $-40^{\circ}\text{C} \sim +40^{\circ}\text{C}$

1-3 Test Conditions :

Tests and measurements shall be made in the following standard conditions unless otherwise specified :

Normal temperature (temperature 5 to  $35^{\circ}\text{C}$ )

Normal humidity (relative humidity 45 to 85%)

Normal pressure (pressure 860 to 1,060 mbars)

In case any question arises from the judgment made, tests shall be conducted in the following conditions:

Temperature (20 $\pm$ 2 $^{\circ}\text{C}$ )

Relative humidity (65 $\pm$ 5%)

Pressure (860 to 1,060 mbars)

## 2. Rating:

2-1 Maximum Rating : 50 mA, DC 12V

3. Type of Actuation : Push – ON Type

4. Contact Arrangement : 1 poles 1 throws (SPST)

## 5. Electrical Characteristics

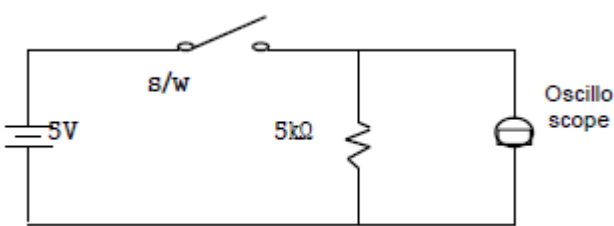
ITEM	DESCRIPTION	TEST CONDITIONS	REQUIREMENTS
5-1	Visual Examination	By visual examination check without any out pressure & testing.	There shall be no defects that affect the serviceability of the product.
5-2	Contact Resistance	① Applying static load twice the actuating force to the center of the stem. ② Measurements shall be made with a 1kHz shall current contact resistance meter.	100mΩ max.
5-3	Insulation Resistance	100V DC, 1minute ±5seconds	100 MΩ min.
5-4	Dielectric withstanding Voltage	250V AC(50Hz or 60Hz)shall be applied between all the adjacent terminal and between the terminal and the frame for 1 minute.	There shall be no breakdown or flashover.
5-5	BOUNCE	Lightly striking the center of the stem at a rate encountered in normal use (3 to 4 operations per sec), Bounce shall be tested when "ON" and "OFF". 	10ms max.



# TACT SWITCH SPECIFICATION

Rev. 01  
P : 3 / 6

## 6. Mechanical Characteristics

ITEM	DESCRIPTION	TEST CONDITIONS	REQUIREMENTS
6-1	Operation Force	Place the switch such that the direction of switch operation is vertical and then gradually increase the load applied to the center of the stem, the maximum load required for the stem to come to a stop shall be measured.	160±50 gf•cm
6-2	Travel	Place the switch such that the direction of switch operation is vertical and then apply a static load twice the actuating force to the center of the stem, the travel distance for the stem to come to a stop shall be measured.	0.25±0.1 mm
6-3	Return Force	The sample switch is installed such that the direction of switch operation is vertical and, upon depression of the stem in its center the whole travel distance, the force of the stem to return to its free position shall be measured.	50 gf•cm min
6-4	Static Strength	Placing the switch such that the direction of switch operation is vertical, a static load of 3kgf shall be applied in the direction of stem operation for a period of 60 seconds.	There shall be no sign of damage mechanically and electrically.
6-5	Operation Life	Measurements shall be made following the test set forth below: 1) 50mA, 12V DC resistive load 2) Rate of operation: 2~3 cycles/sec 3) Step of operation: 50,000 steps	1)As shown in item 5-3, 5-4 2)Contact Resistance: 200mΩ max

## 7. Environmental Characteristics

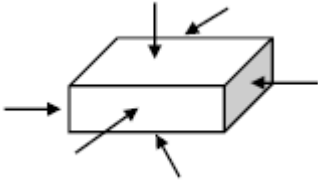
ITEM	DESCRIPTION	TEST CONDITIONS	REQUIREMENTS
7-1	Moisture Resistance	<p>Following the test set forth below the sample shall be left in normal temperature and easurements. Are made :</p> <ol style="list-style-type: none"> <li>1) Temperature : <math>60\pm 2^{\circ}\text{C}</math></li> <li>2) Relative humidity : 90 to 95%</li> <li>3) Time : 96 hours</li> </ol> <p>Water drops shall be removed.</p>	<p>Contact resistance : 200m<math>\Omega</math> Max.</p> <p>Insulation resistance : 100M<math>\Omega</math> Min.</p>
7-2	Resistance Low Temperature	<p>Following the test set forth below the sample shall be left in normal temperature and humidity conditions for an hour before measurements are made:</p> <ol style="list-style-type: none"> <li>1)Temperature: <math>-30^{\circ}\text{C}\pm 2^{\circ}\text{C}</math></li> <li>2)Time: 96 hours</li> </ol> <p>Water drops shall be removed.</p>	<p>Contact resistance: 200m<math>\Omega</math> Max.</p> <p>Insulation resistance : 100M<math>\Omega</math> Min.</p>
7-3	Resistance High Temperature	<p>Following the test set forth below the sample shall be left in normal temperature and humidity conditions for an hour before measurements are made:</p> <ol style="list-style-type: none"> <li>1)Temperature: <math>80^{\circ}\text{C}\pm 2^{\circ}\text{C}</math></li> <li>2)Time: 96 hours</li> </ol>	<p>Contact resistance: 200m<math>\Omega</math> Max.</p> <p>Insulation resistance : 100M<math>\Omega</math> Min.</p>
7-4	Impact Shock Resistance	<p>Measurements shall be made following the test set forth below :</p> <ol style="list-style-type: none"> <li>1) Acceleration : 80G</li> <li>2) Cycles of test : 3 cycles each in 6 directions, for a total of 18 cycles.</li> </ol> 	<p>Item 5 Item 6-1, 6-2</p>



# TACT SWITCH SPECIFICATION

Rev. 01  
P : 5 / 6

ITEM	DESCRIPTION	TEST CONDITIONS	REQUIREMENTS
7-5	Change of Temperature	<p>Following ten cycles of high temperature test. The sample shall be placed in normal temperature and humidity conditions for one hour before measurements are made. During this test, water drops shall be removed.</p> <p style="text-align: center;">Cycling : 1 cycle</p>	<p>Contact resistance : 200mΩ Max. Insulation resistance : 100MΩ Min.</p>
7-6	Vibration Resistance	<p>Measurements shall be made following the test set forth below :</p> <ol style="list-style-type: none"> <li>1) Range of oscillation : 10 to 55Hz</li> <li>2) Amplitude, peak to peak : 1.5mm</li> <li>3) Cycle of sweep : 10-55-10Hz in a minute.</li> <li>4) Mode of sweep : Logarithmically seep or uniform sweep.</li> <li>5) Direction of oscillation : Three mutually perpendicular direction, including the direction of stem travel.</li> <li>6) 2 hours each for a total of 6 hours.</li> </ol>	<p>Item 5 Item 6-1, 6-2</p>

8. This item is "RoHS" Compliant

9. Manual Soldering : Max 350°C, 3 sec.

10. Wave Soldering : Max 280°C, 5 sec.

11. Reflow Soldering Conditions: (SMD type only)

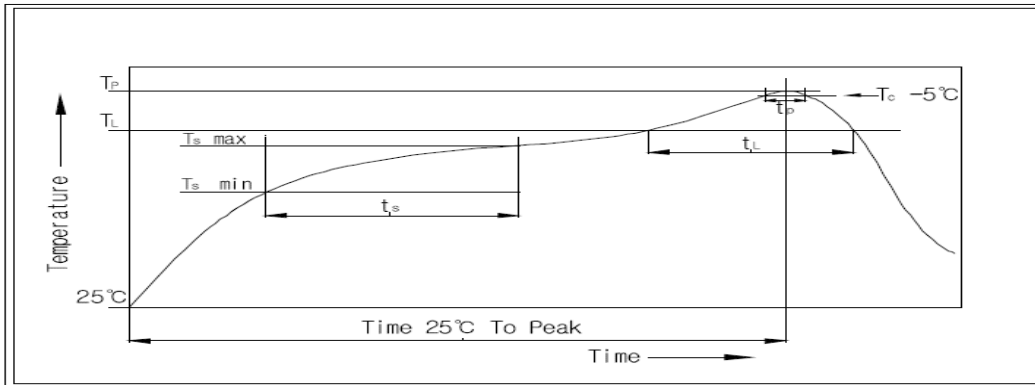

## 11-1 Condition for Soldering

Profile Feature	Pb-Free Assembly
Average Ramp-UP Rate( $T_s$ max to $T_P$ )	3°C/second max
Preheat	
- Temperature Min( $T_s$ min)	150°C
- Temperature Max( $T_s$ max)	200°C
- Time ( $t_s$ min to $t_s$ max)	60-180seconds
Time maintained above:	
- Temperature ( $T_L$ )	217°C
- Time ( $t_L$ )	60-150seconds
Peak/Classification Temperature( $T_P$ )	260°C +0°C/ -5°C
Time within 5°C of actual Peak Temperature( $T_P$ )	5~10 seconds
Ramp-Down Rate	6°C/sec max
Time 25°C to Peak Temperature	8 minutes max

MRK.	DATE	REVISION	SIGN
△			

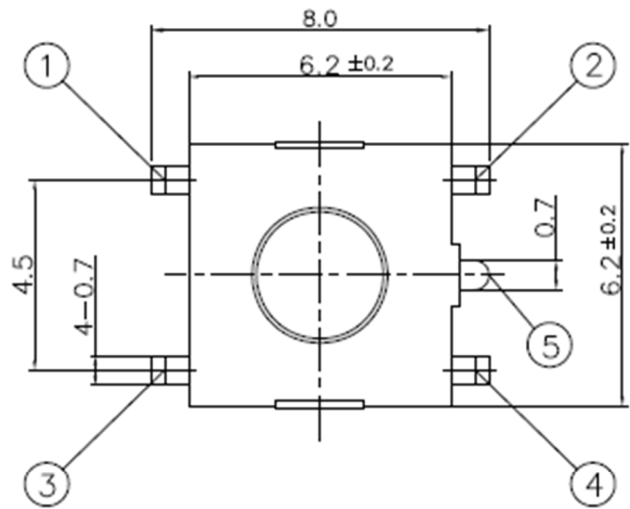

P.C.B LAND PATTERN

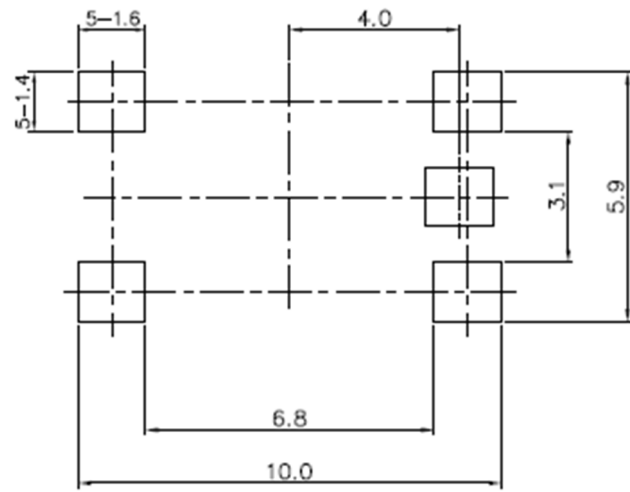

CIRCUIT DIAGRAM

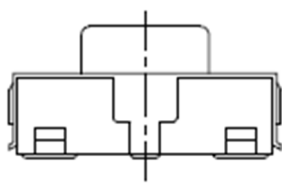
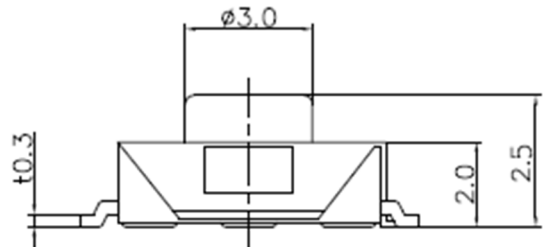
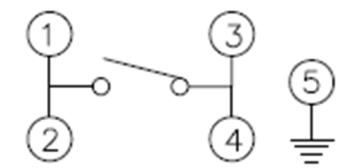

SPECIFICATION

1. RATING : DC 12V 50mA
2. TRAVEL : 0.25±0.1mm
3. CONTACT RESISTANCE : 100mΩ MAX.
4. BOUNCE : 10m SEC MAX.
5. OPERATING FORCE : 160±50gf
6. LIFE CYCLES : 80,000 CYCLE

01	-	-	-	1	-
NO.	DESCRIPTION	MATERIAL	COLOR/FINISH	Q.TY	VENDOR
W.J.LEE	J.P.ROH	K.L.LEE	TITLE TACT		
			MODEL SWITCH		SHEET
 深圳市子庚科技有限公司			UNIT mm	SCALE 4:1	DRAW NO. STP-1125
			SIZE A4		