

MINIATURE RELAY

2 POLES - 1 to 2 A (For Signal Switching)

NA Series

■ FEATURES

- Slim type relay for high density mounting
 - Conforms to Telcordia specification and FCC Part 68
 - Dielectric strength 1,500 VAC between coil and contacts
 - Surge strength 2,500 V between coil and contacts (at 2 × 10 s surge wave)
 - UL, CSA recognized
 - High sensitivity and low consumption power
 - High reliability - bifurcated contacts
 - DIL pitch terminals
 - Plastic sealed type
 - RoHS compliant.
- Please see page 8 for more information

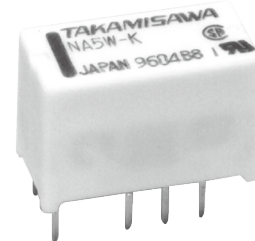

■ PARTNUMBER INFORMATION

[Example] $\frac{NA}{(a)}$ $\frac{L}{(b)}$ - $\frac{D}{(*)}$ $\frac{12}{(c)}$ $\frac{W}{(d)}$ - $\frac{K}{(f)}$

(a)	Relay type	NA	: NA-Series
(b)	Coil type	Nil L	: Standard type : Latching type (1 coil)
(c)	Number of coil	Nil D	: Single winding type : Double winding type
(d)	Coil rated voltage	12	: 1.5.....48 VDC Coil rating table at page 3
(e)	Contact	W	: Bifurcated type
(f)	Enclosure	K	: Plastic sealed type

Note: Actual marking omits the hyphen (-) of (*).

■ SPECIFICATION

Item			Standard type	Single winding latching type	Double winding latching type
			NA - () W - K	NAL - () W - K	NAL-D () W - K
Contact Data	Configuration		2 form C (DPDT)		
	Construction		Bifurcated		
	Material		Gold overlay silver alloy (AgPd)		
	Resistance (Initial)		Max. 50 mΩ at 1 A, 6 VDC		
	Contact rating (resistive)		0.5A, 125VAC or 1A, 30VDC		
	Max. carrying current		2A		
	Max. switching voltage		250VAC / 220VDC		
	Max. switching power		62.5VA / 30W		
	Max. switching current		2A		
	Min. switching load *		0.01 mA, 10 mVDC		
	Capacitance (at 1kHz, reference)		Approx. 0.5 pF (open contacts, adjacent contacts) Approx. 1.0 pF (between coil and contacts)		
Life	Mechanical		Min. 100 x 10 ⁶ operations	Min. 10 x 10 ⁶ operations	
	Electrical		Min. 200 x 10 ³ operations (0.5A, 125VAC), Min. 500 x 10 ³ operations (1A, 30VDC)		
Coil Data	Rated power		140 - 300 mW	100 - 150 mW	200 - 300 mW
	Applied pulse width			min. 10ms	
	Operate power		80 - 70 mW	60 - 85 mW	115 - 170 mW
	Operating temperature range		-40 °C to +85 °C (no frost)		
Timing Data	Operate (at nominal voltage, without bounce)		Max. 6 ms	Max. 6 ms (set)	
	Release (at nominal voltage, without bounce)		Max. 4 ms	Max. 6 ms (reset)	
Insulation	Resistance (Initial)		Min. 1,000MΩ at 500VDC		
	Dielectric strength	Open contacts / adjacent contacts	1,000VAC (50/60Hz) 1min		
		Contacts to coil	1,500VAC (50/60Hz) 1min.	1,000VAC (50/60Hz) 1min	
	Surge strength	Open contacts / adjacent contacts	1,500V / 10 x 700μs standard wave		
		Coil to contacts	2,500V / 2 x 10μs standard wave	1,500V / 10 x 160μs standard wave	
Other	Vibration resistance	Misoperation	10 to 55 to 10Hz single amplitude 1.65mm		
		Endurance	10 to 55 to 10Hz single amplitude 2.5mm		
	Shock	Misoperation	500m/s ² (11 ± 1ms)		
		Endurance	1,000m/s ² (6 ± 1ms)		
	Weight		Approximately 1.6 g		

* Minimum switching loads mentioned above are reference values. Please perform the confirmation test with actual load before production since reference values may vary according to switching frequencies, environmental conditions and expected reliability levels.

■ COIL RATING

Standard type

Coil Code	Rated Coil Voltage (VDC)	Coil Resistance +/- 10% (Ohm)	Must Operate Voltage (VDC) *	Must Release Voltage (VDC) *	Rated Power (mW)
1.5	1.5	16.1	+1.13	+0.15	140
3	3	64.3	+2.25	+0.3	
4.5	4.5	145	+3.38	+0.45	
5	5	178	+3.75	+0.5	
6	6	257	+4.5	+0.6	
9	9	579	+6.75	+0.9	
12	12	1,028	+9	+1.2	
18	18	1,620	+13.5	+1.8	200
24	24	2,880	+18	+2.4	
48	48	7,680	+36	+4.8	300

Single winding latching type

Coil Code	Rated Coil Voltage (VDC)	Coil Resistance +/- 10% (Ohm)	Set Voltage (VDC) *	Reset Voltage (VDC) *	Rated Power (mW)
1.5	1.5	22.5	+1.13	-1.13	100
3	3	90	+2.25	-2.25	
4.5	4.5	203	+3.38	-3.38	
5	5	250	+3.75	-3.75	
6	6	360	+4.5	-4.5	
9	9	810	+6.75	-6.75	
12	12	1,440	+9	-9	
18	18	2,160	+13.5	-13.5	150
24	24	3,840	+18	-18	

Note: All values in the tables are valid for 20°C and zero contact current.

* Specified operate values are valid for pulse wave voltage.

Please use at rated coil voltage. Please refer to characteristic data and set up adequate voltage in case of use at over voltage.

■ COIL RATING

Double winding latching type

Coil Code	Rated Coil Voltage (VDC)	Coil Resistance +/- 10% (Ohm)	Set Voltage (VDC) *	Reset Voltage (VDC) *	Rated Power (mW)
1.5	1.5	P 11.25	+1.13		200
		S 11.25		+1.13	
3	3	P 45	+2.25		
		S 45		+2.25	
4.5	4.5	P 101	+3.38		
		S 101		+3.38	
5	5	P 125	+3.75		
		S 125		+3.75	
6	6	P 180	+4.5		
		S 180		+4.5	
9	9	P 405	+6.75		
		S 405		+6.75	
12	12	P 720	+9		
		S 720		+9	
18	18	P 1,080	+13.5		300
		S 1,080		+13.5	
24	24	P 1,920	+18		
		S 1,920		+18	

Note: All values in the table are measured at 20°C and zero contact current.

P: Primary coil S: Secondary coil

* Specified values are measured with pulse wave voltage

Please use at rated coil voltage. Please refer to characteristic data and set up adequate voltage in case of use at over voltage.

■ SAFETY STANDARDS

Type	Compliance	Contact rating
UL	UL 508, UL 1950	Flammability: UL 94-V0 (plastics)
	E 45026	0.5A, 125VAC (general use) 2A, 30VDC (resistive)
CSA	C22.2 No. 14, No. 950 LR 35579	0.3A, 110VDC (resistive)

Complies to IEC60950-1; FCC part 68: Telcordia
(Relay is only marked with UL and CSA logo)

CHARACTERISTIC DATA

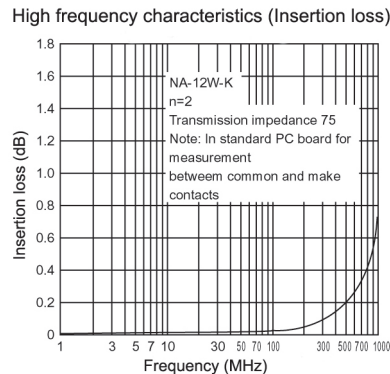
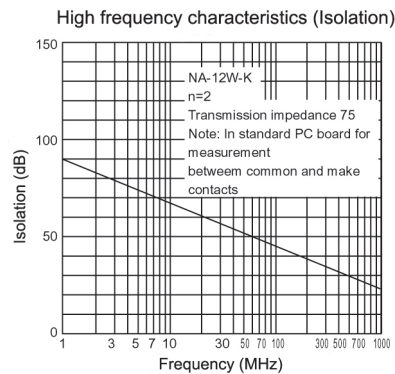
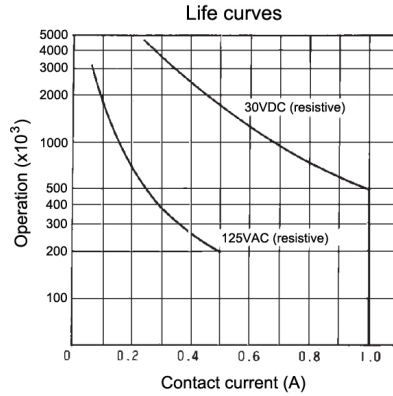
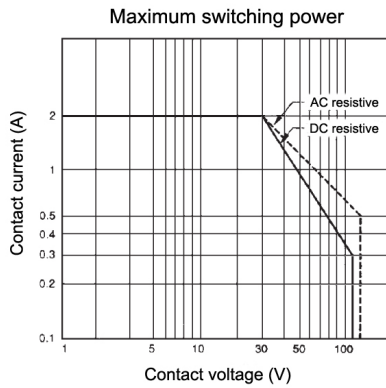
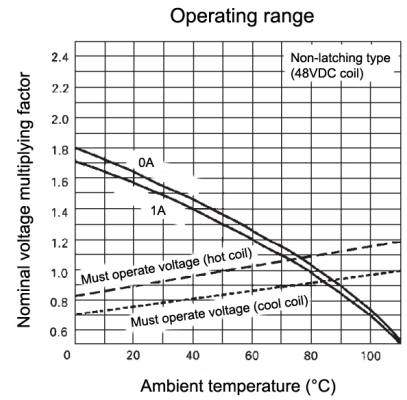
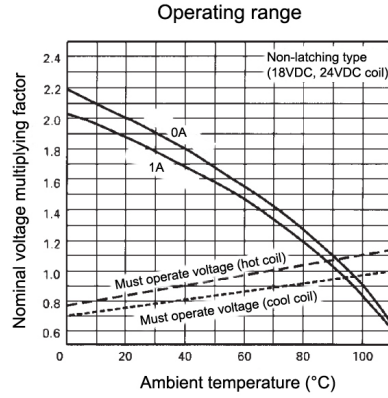
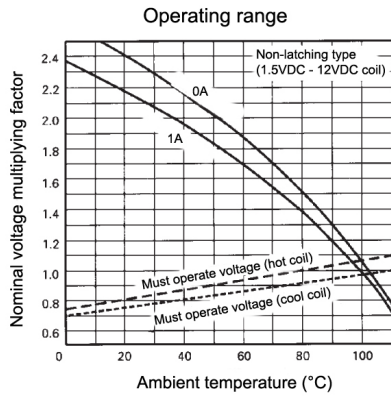
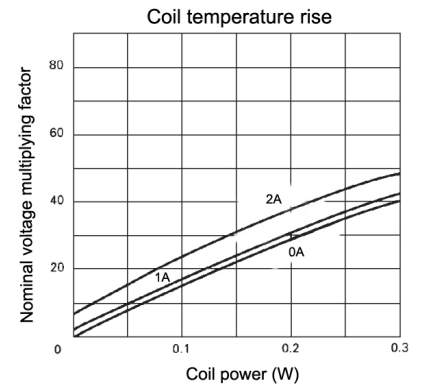
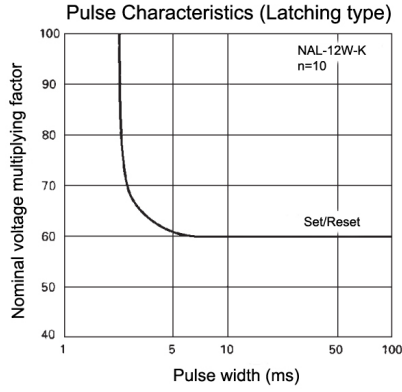
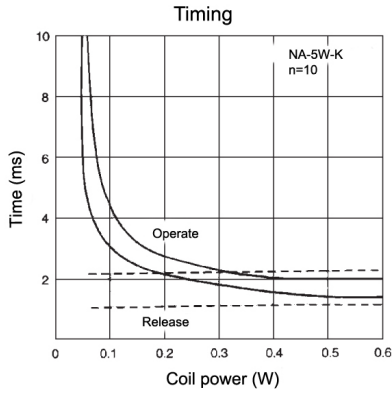

NA SERIES

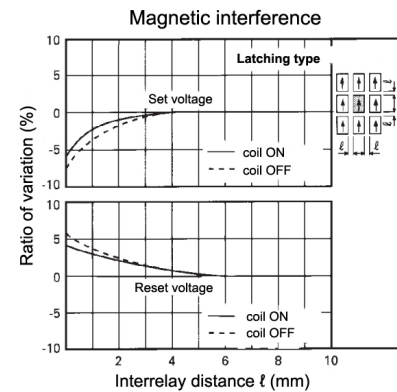
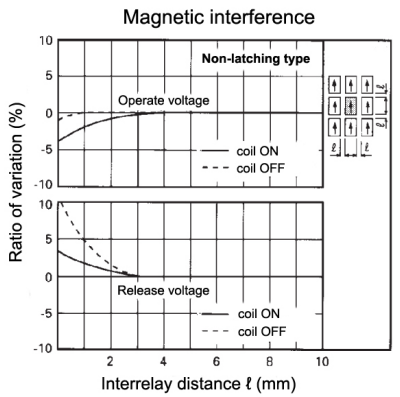
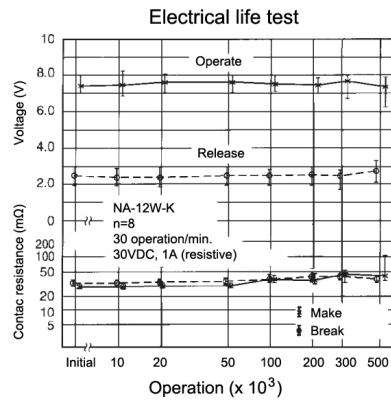
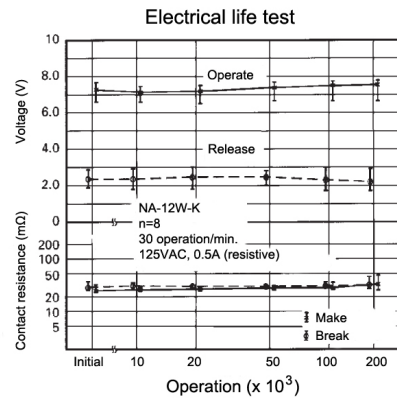
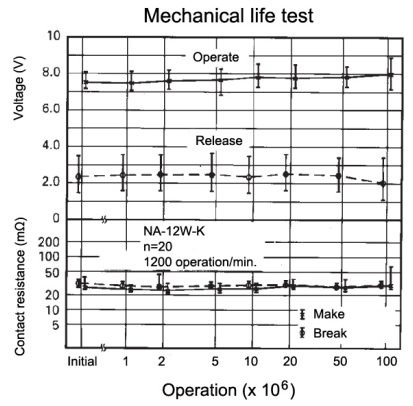
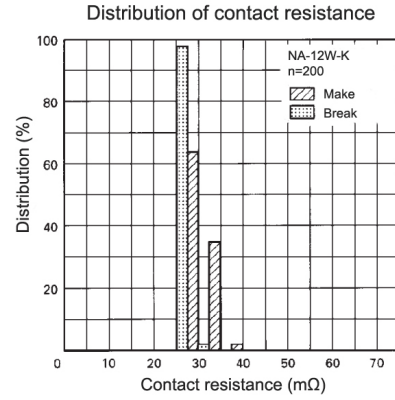
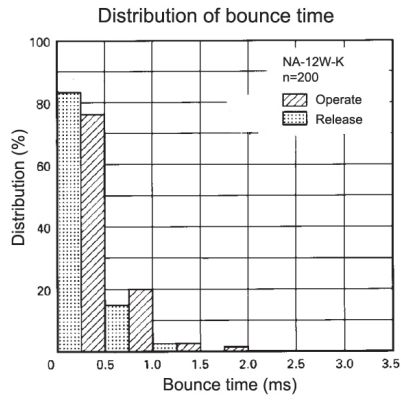
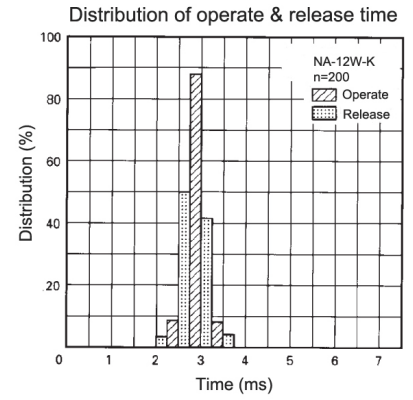
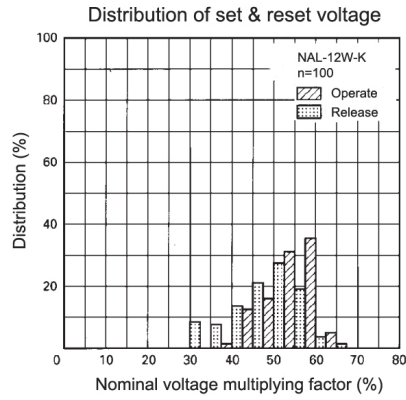
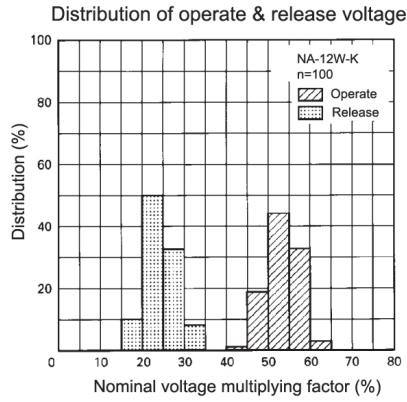

■ DIMENSIONS

NA (standard type)
NAL (single winding latching type)

● Dimensions

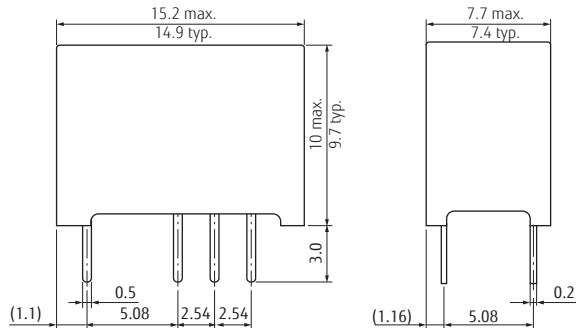

● Schematics (BOTTOM VIEW)

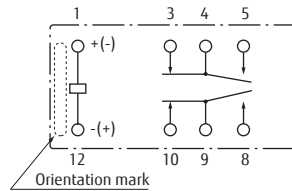

● PC board mounting hole layout (BOTTOM VIEW)

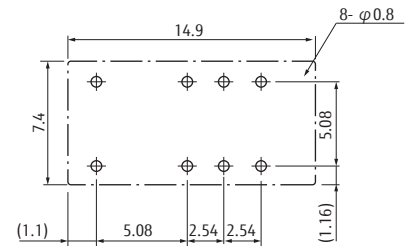

NAL-D (double winding latching type)

● Dimensions

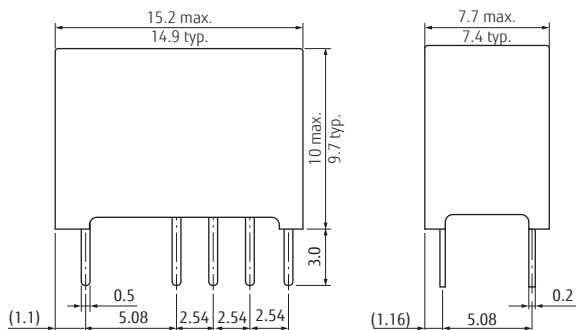

● Schematics (BOTTOM VIEW)

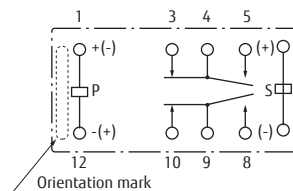

● PC board mounting hole layout (BOTTOM VIEW)

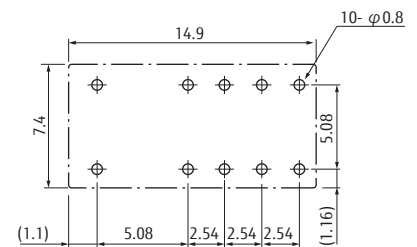

- * Contacts drawn in reset condition.
- * +/-: set voltage applied polarity, (+)/(-): reset voltage applied polarity.
- * P: Set coil, S: Reset coil

- * Dimensions of the terminals do not include thickness of pre-solder.
- * Dimensions do not include tolerances.
- * Tolerances of PC board mounting hole layout: ± 0.1 unless otherwise specified.

Unit: mm

RoHS Compliance and Lead Free Information

1. General Information

- All relays produced by Fujitsu Components are compliant with RoHS directive 2011/65/EU including amendments.
- Cadmium as used in electrical contacts is exempted from the RoHS directives. As per Annex III of directive 2011/65/EU.
- All relays are lead-free. Please refer to Lead-Free Status Info for older date codes at: <http://www.fujitsu.com/downloads/MICRO/fcai/relays/lead-free-letter.pdf>
- Lead free solder plating on relay terminals is Sn-3.0Ag-0.5Cu, unless otherwise specified. This material has been verified to be compatible with PbSn assembly process.

2. Recommended Lead Free Solder Condition

- Recommended solder Sn-3.0Ag-0.5Cu.

Flow Solder Condition:

Pre-heating: maximum 120 °C
within 90 sec.
Soldering: dip within 5 sec. at
255 °C ± 5 °C solder bath
Relay must be cooled by air immediately
after soldering

Solder by Soldering Iron:

Soldering Iron 30-60W
Temperature: maximum 350-360 °C
Duration: maximum 3 sec.

We highly recommend that you confirm your actual solder conditions

3. Moisture Sensitivity

- Moisture Sensitivity Level standard is not applicable to electromechanical relays, unless otherwise indicated.

4. Tin Whiskers

- Dipped SnAgCu solder is known as presenting a low risk to tin whisker development. No considerable length whisker was found by our in house test.

Fujitsu Components International Headquarter Offices

Japan FUJITSU COMPONENT LIMITED Shinagawa Seaside Park Tower 19F, 12-4, Higashi-shinagawa 4-chome, Shinagawa-ku, Tokyo, 140-0002, Japan Tel: (81-3) 3450-1682 Fax: (81-3) 3474-2385 Email: fcl-contact@cs.jp.fujitsu.com Web: www.fujitsu.com/jp/fcl/	Asia Pacific FUJITSU COMPONENTS ASIA, LTD. 102E Pasir Panjang Road #01-01 Citilink Warehouse Complex Singapore 118529 Tel: (65) 6375-8560 Fax: (65) 6273-3021 Email: fcal@sg.fujitsu.com Web: www.fujitsu.com/sg/products/devices/components	Korea FUJITSU COMPONENTS KOREA LIMITED Alpha Tower #403, 645 Sampyeong-dong, Bundang-gu, Seongnam-si, Gyeonggi-do, 13524 Korea Tel: (82) 31-708-7108 Fax: (82) 31-709-7108 Email: fcal@sg.fujitsu.com www.fujitsu.com/sg/products/devices/components/
North and South America FUJITSU COMPONENTS AMERICA, INC 2290 North First Street, Suite 212 San Jose, CA 95131, USA Tel: (1-408) 745-4900 Fax: (1-408) 745-4970 Email: components@us.fujitsu.com Web: us.fujitsu.com/components	China FUJITSU ELECTRONIC COMPONENTS (SHANGHAI) CO., LTD. Unit 4306, InterContinental Center 100 Yu Tong Road, Shanghai 200070, China Tel: (86-21) 3253 0998 Fax: (86-21) 3253 0997 Email: fcsch@cn.fujitsu.com Web: www.fujitsu.com/cn/products/devices/components/	
Europe FUJITSU COMPONENTS EUROPE B.V. Diamantlaan 25 2132 WV Hoofddorp Netherlands Tel: (31-23) 5560910 Fax: (31-23) 5560950 Email: info@fceu.fujitsu.com Web: www.fujitsu.com/uk/components	Hong Kong FUJITSU COMPONENTS HONG KONG CO., LTD Unit 506, Inter-Continental Plaza No.94 Granville Road, Tsim Sha Tsui, Kowloon, Hong Kong Tel: (852) 2881-8495 Tex: (852) 2894-9512 Email: fcal@sg.fujitsu.com Web: www.fujitsu.com/sg/products/devices/components/	

© 2019 Fujitsu Components Europe B.V. All rights reserved. All trademarks or registered trademarks are the property of their respective owners.

The contents, data and information in this datasheet are provided by Fujitsu Component Ltd. as a service only to its user and only for general information purposes. The use of the contents, data and information provided in this datasheet is at the users' own risk.

Fujitsu has assembled this datasheet with care and will endeavor to keep the contents, data and information correct, accurate, comprehensive, complete and up to date.

Fujitsu Components Europe B.V. and affiliated companies do however not accept any responsibility or liability on their behalf, nor on behalf of its employees, for any loss or damage, direct, indirect or consequential, with respect to this datasheet, its contents, data, and information and related graphics and the correctness, reliability, accuracy, comprehensiveness, usefulness, availability and completeness thereof.

Nor do Fujitsu Components Europe B.V. and affiliated companies accept on their behalf, nor on behalf of its employees, any responsibility or liability with respect to these datasheets, its contents, data, information and related graphics and the correctness, reliability, accuracy, comprehensiveness, usefulness, availability and completeness thereof. Rev. July 9, 2019