

N-Channel 100-V (D-S) MOSFET

GENERAL DESCRIPTION

The ME110N10T and ME110N10F is the N-Channel logic enhancement mode power field effect transistors, using high cell density, DMOS trench technology. This high density process is especially tailored to minimize on state resistance.

FEATURES

- $R_{DS(ON)} \leq 6.2m\Omega @ V_{GS}=10V$
- Super high density cell design for extremely low $R_{DS(ON)}$
- Exceptional on-resistance and maximum DC current capability

PIN CONFIGURATION

(TO-220AB)

Top View

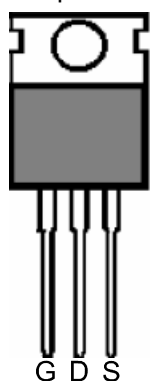

(TO-220F)

Top View

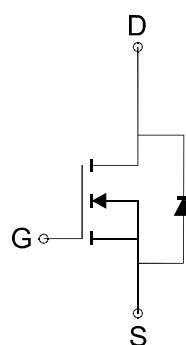
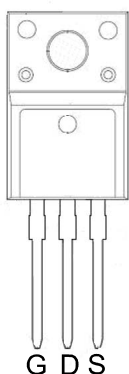

N-Channel MOSFET

Ordering Information : ME110N10T(TO-220AB)
ME110N10F(TO-220F)

Absolute Maximum Ratings (TA=25°C Unless Otherwise Noted)

Parameter		Symbol	Rating	Unit
Drain-Source Voltage		V_{DSS}	100	V
Gate-Source Voltage		V_{GSS}	± 25	V
Continuous Drain Current*	$T_C=25^\circ C$	I_D	140	A
	$T_C=100^\circ C$		105	
Pulsed Drain Current		I_{DM}	550	A
Maximum Power Dissipation	$T_C=25^\circ C$	P_D	217	W
	$T_C=100^\circ C$		108	
Operating Junction Temperature		T_J	-55 to 175	$^\circ C$
Thermal Resistance-Junction to Case**		$R_{\theta JC}$	0.69	$^\circ C/W$

* Calculated continuous current based on maximum allowable junction temperature. Package limitation current is 140A.

** The device mounted on 1in² FR4 board with 2 oz copper.

N-Channel 100-V (D-S) MOSFET
Electrical Characteristics (TA=25°C Unless Otherwise Specified)

Symbol	Parameter	Limit	Min	Typ	Max	Unit
STATIC						
BV _{DSS}	Drain-Source Breakdown Voltage	V _{GS} =0V, I _D =250 μA	100			V
V _{GS(th)}	Gate Threshold Voltage	V _{DS} =V _{GS} , I _D =250 μA	2	3	4	V
I _{GSS}	Gate Leakage Current	V _{DS} =0V, V _{GS} =±25V			±100	nA
I _{DSS}	Zero Gate Voltage Drain Current	V _{DS} =100V, V _{GS} =0V			1	μA
R _{DS(ON)} (TO-220AB)	Drain-Source On-Resistance ^a	V _{GS} =10V, I _D =70A		6.2	7.5	mΩ
R _{DS(ON)} (TO-220F)	Drain-Source On-Resistance ^a	V _{GS} =10V, I _D =70A		7.0	8.0	mΩ
V _{SD}	Diode Forward Voltage	I _S =70A, V _{GS} =0V		0.8	1.0	V
DYNAMIC						
Q _g	Total Gate Charge	V _{DS} =80V, V _{GS} =10V, I _D =70A		130		nC
Q _{gs}	Gate-Source Charge			25		
Q _{gd}	Gate-Drain Charge			32		
C _{iss}	Input Capacitance	V _{DS} =25V, V _{GS} =0V, f=1MHz		6140		pF
C _{oss}	Output Capacitance			943		
C _{rss}	Reverse Transfer Capacitance			490		
R _g	Gate-Resistance	V _{DS} =0V, V _{GS} =0V, f=1MHz		1.7		Ω
t _{d(on)}	Turn-On Delay Time	V _{DD} =50V, R _G =6Ω, V _{GS} =10V, I _{DS} =70A		23		ns
t _r	Turn-On Rise Time			39		
t _{d(off)}	Turn-Off Delay Time			86		
t _f	Turn-Off Fall Time			46		

Notes: a. Pulse test: pulse width ≤ 300us, duty cycle ≤ 2%, Guaranteed by design, not subject to production testing.

b. Matsuki reserves the right to improve product design, functions and reliability without notice.

N-Channel 100-V (D-S) MOSFET

Typical Characteristics (T_J = 25°C Noted)

Power Dissipation

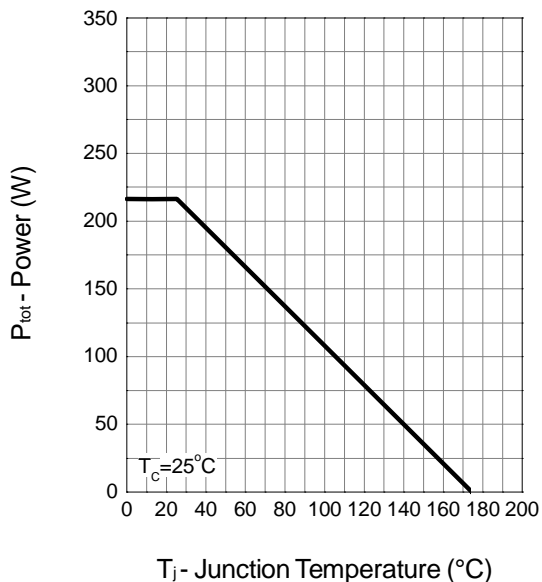

Drain Current

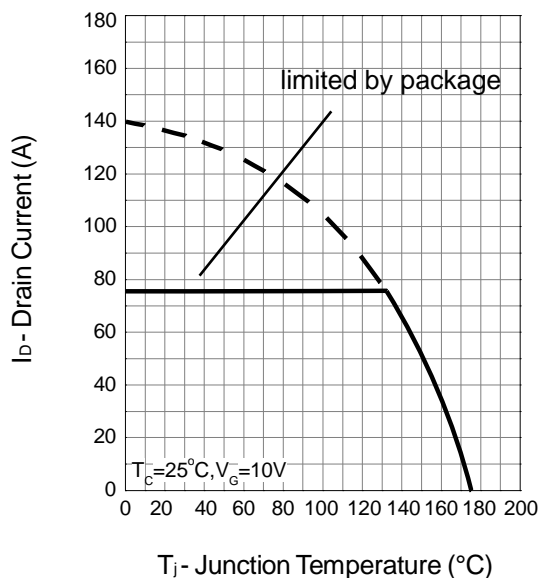

Safe Operation Area

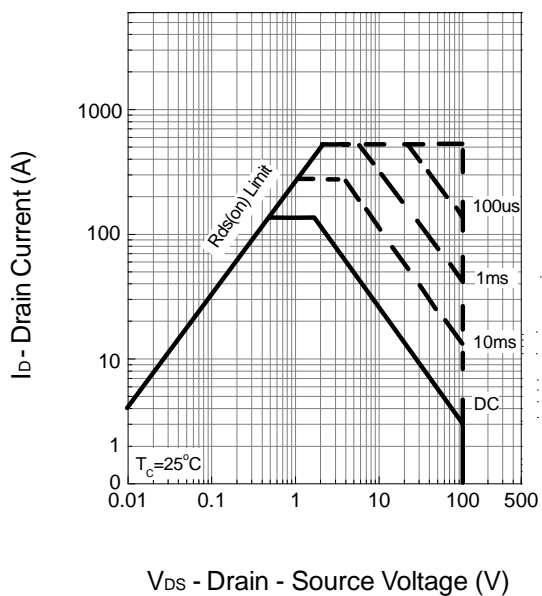

Thermal Transient Impedance

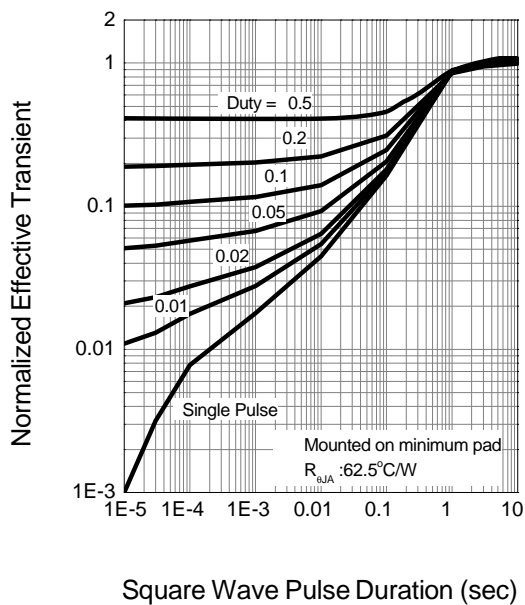

N-Channel 100-V (D-S) MOSFET

Typical Characteristics (T_J = 25°C Noted)

Output Characteristics

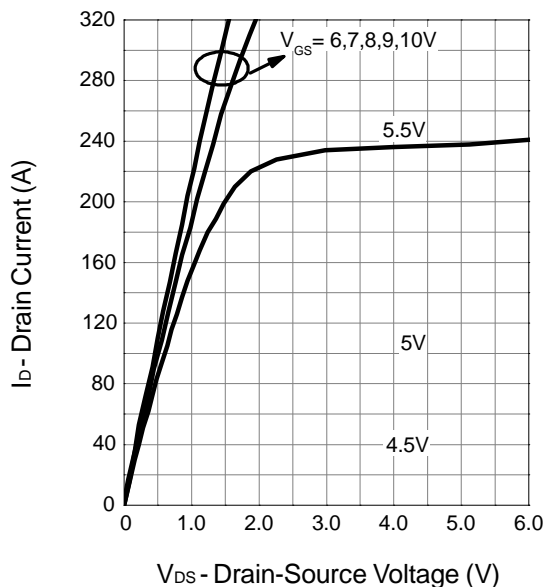

Drain-Source On Resistance

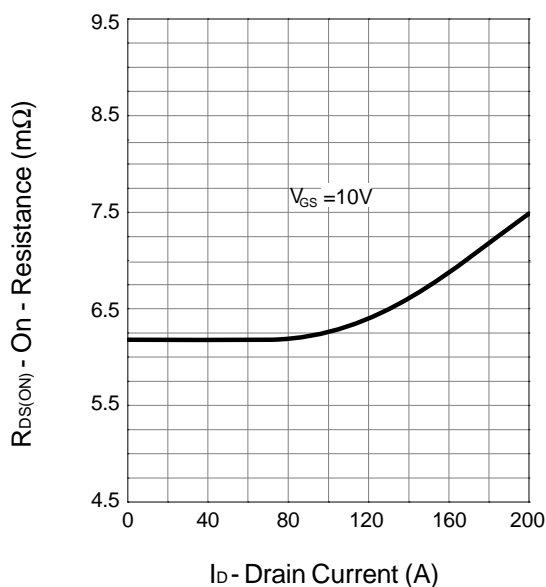

Drain-Source On Resistance

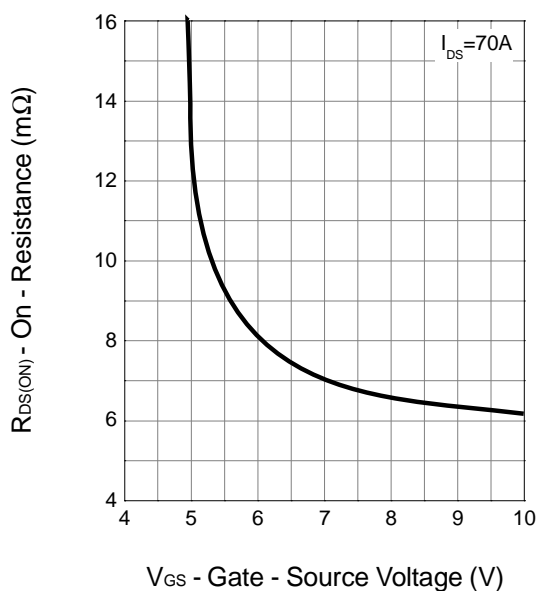

Gate Threshold Voltage

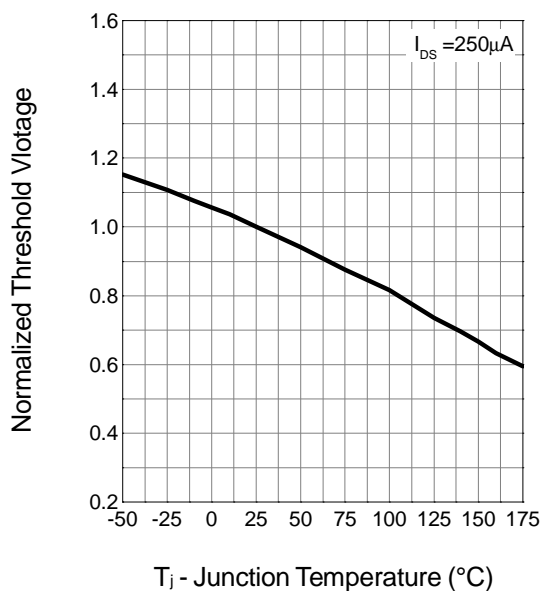

N-Channel 100-V (D-S) MOSFET

Typical Characteristics (T_J =25°C Noted)

Drain-Source On Resistance

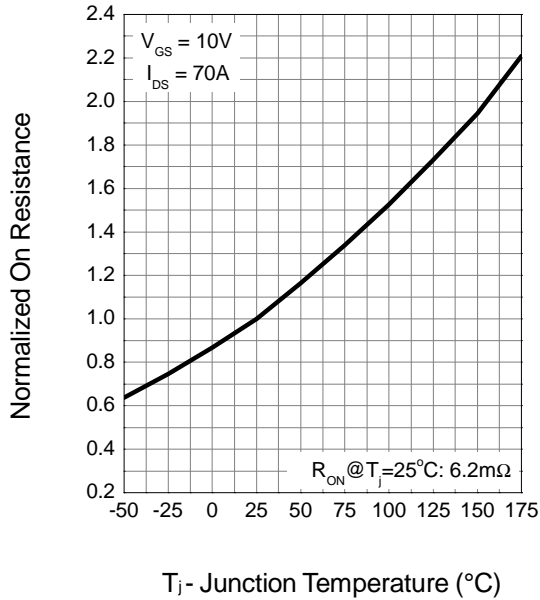

Source-Drain Diode Forward

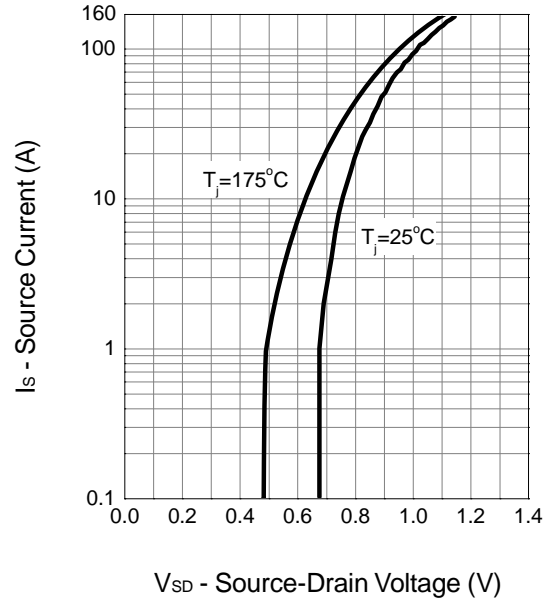

Capacitance

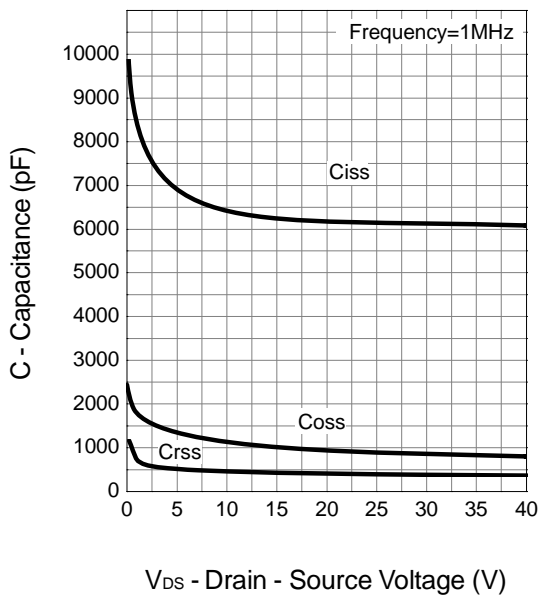

Gate Charge

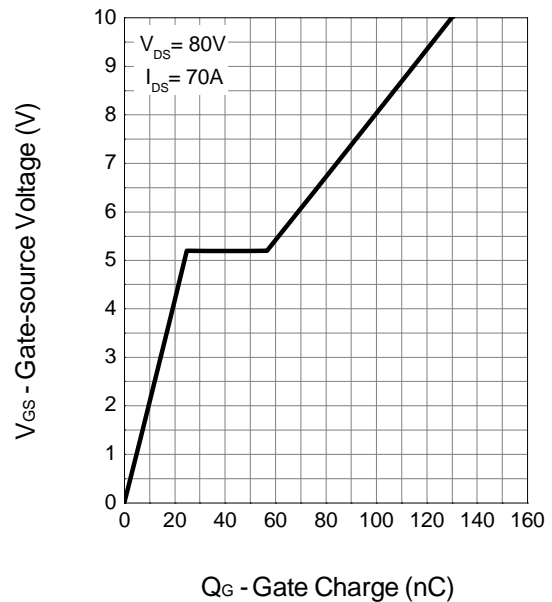

TO-220AB Package Outline

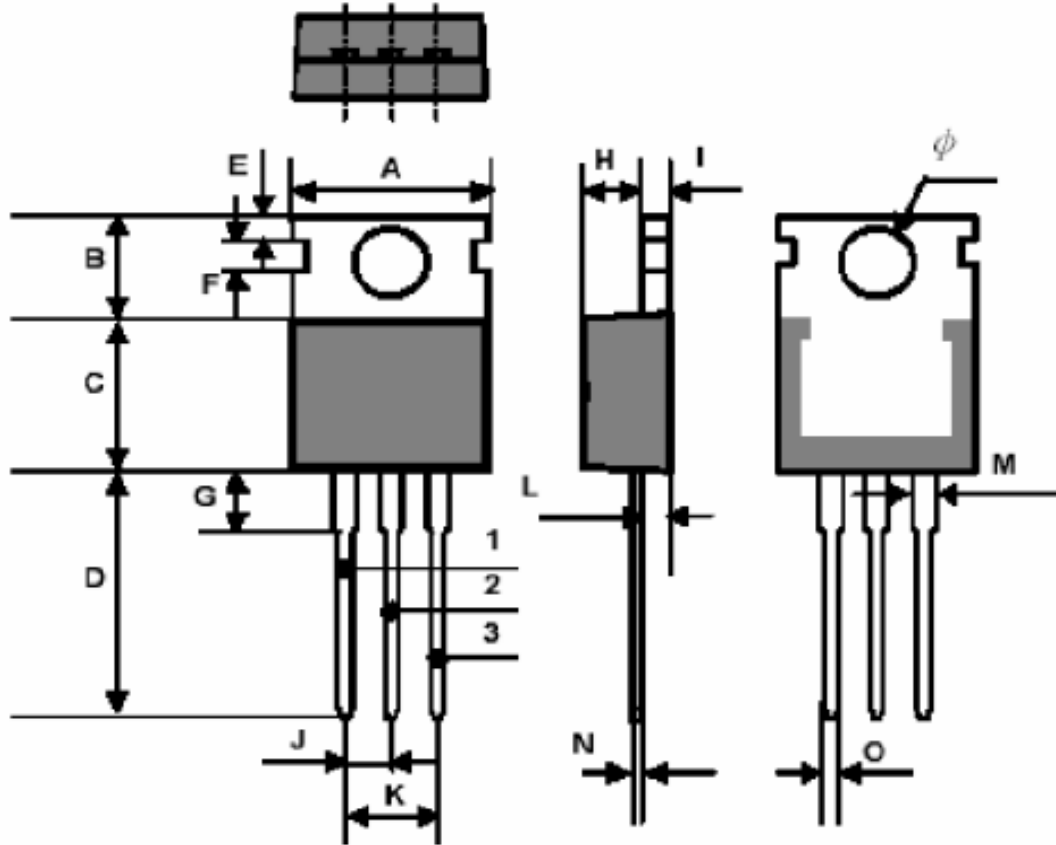

Symbol	MILLIMETERS		INCHES	
	Min	Max	Min	Max
A	9.7	10.1	0.382	0.398
B	6.3	6.7	0.248	0.264
C	9	9.47	0.354	0.373
D	12.8	13.3	0.504	0.524
E	1.2	1.4	0.047	0.055
F	1.7TYP		0.067TYP	
G	2.65TYP		0.104TYP	
H	3	3.4	0.118	0.134
I	1.25	1.4	0.049	0.055
J	2.4	2.7	0.094	0.106
K	5	5.15	0.197	0.203
L	2.2	2.6	0.087	0.102
M	1.25	1.45	0.049	0.057
N	0.45	0.6	0.018	0.024
O	0.7	0.9	0.027	0.035
φ	3.6		0.142	

TO-220F Package Outline

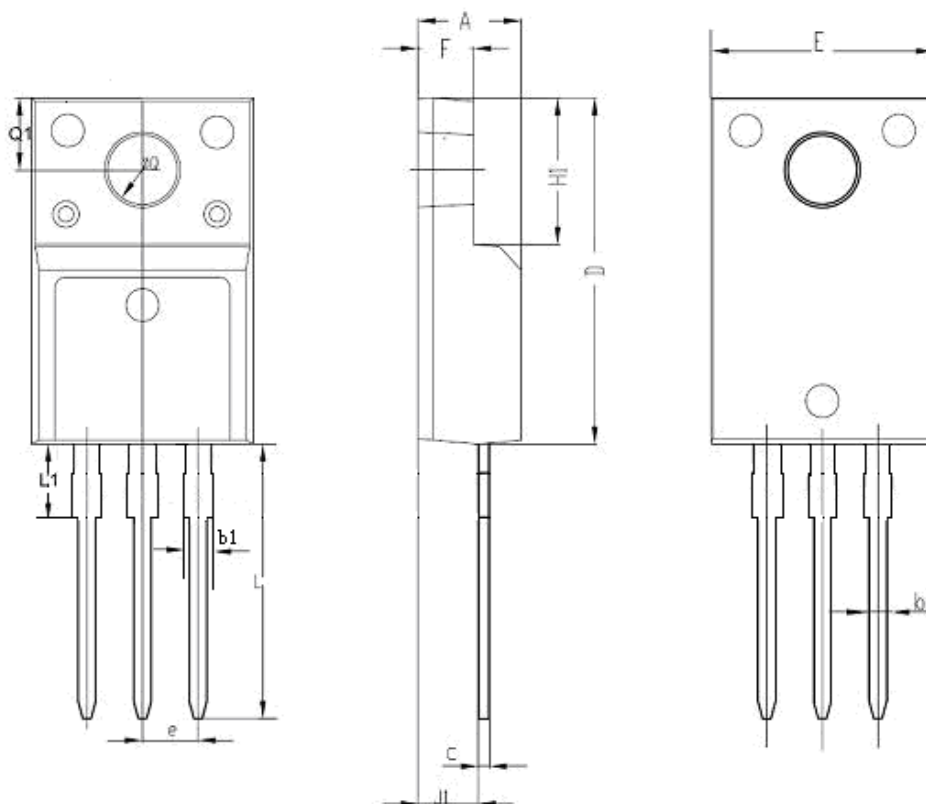

SYMBOL	INCHES		MILLIMETERS		NOTES
	MIN	MAX	MIN	MAX	
A	0.178	0.194	4.53	4.93	
b	0.028	0.036	0.71	0.91	
C	0.018	0.024	0.45	0.60	
D	0.617	0.633	15.67	16.07	
E	0.392	0.408	9.96	10.36	
e	0.100 TYP.		2.54 TYP.		
H1	0.256	0.272	6.50	6.90	
J1	0.101	0.117	2.56	2.96	
L	0.503	0.519	12.78	13.18	
φQ	0.117	0.133	2.98	3.38	
b1	0.045	0.055	1.15	1.39	
L1	0.114	0.130	2.9	3.3	
Q1	0.122	0.138	3.10	3.50	
F	0.092	0.108	2.34	2.74	